

20  
24

# PRODUCT CATALOGUE

SITE PROTECTION  
PROFESSIONAL CLOTHING  
PERSONAL PROTECTION



2024  
CATALOGUE

50  
ANS



Protéger, c'est notre métier

# 50 YEARS OF EXPERIENCE AT YOUR SIDE

It seems like only yesterday... From our beginnings in the centre of Paris to today, we have come a long way!

It is still with the same enthusiasm and the same high standards that we work alongside you to equip painters, building and finishing professionals in their day-to-day work.

The company may have grown, but its family spirit and local approach are still there to serve you even better.

Thank you for your loyalty!



Warehouse in Sucy, storage of tarps



**1974:**

Creation of the family business.



**1996:**

DULARY company moved to Sucy-en-Brie (current headquarters)

**2006:**

Dulary joined Multiplast (manufacturer of plastic films and tarps), creation of the MULTIPLAST-DULARY group



**2009:**

New Dulary logo



**2016:**

Logo modernisation



**2022:**

New website



**2021:**

New visual identity



**2024:**

50 years of the brand



**With Dulary, it's a long story... a story that lasts!**

I think I've always known about the brand, ever since I started with the small shop. Things have changed since then... The shop has grown, and Dulary is still there, with products that are as good as ever.

**Alain,**  
Manager of a paint and decoration shop, West



# EXPERTISE AT YOUR SERVICE TO PROTECT SITES AND PEOPLE

For professionals, protecting their sites and their teams is a guarantee of quality and professionalism.

That is why Dulary offers a comprehensive range of site protection solutions: Protective films and tarps, bags, etc., and people: professional clothing and Personal Protective Equipment (PPE).



FRENCH COMPANY WITH 50 YEARS OF EXPERIENCE



NATIONWIDE PRESENCE & INTERNATIONAL OUTLOOK



EVER HIGHER STANDARDS

## 01 SITE PROTECTION

- Plastic tarp ..... p. 10
- CHOOSING YOUR SITE PROTECTION: plastic tarp ..... p. 12**
- Outdoor floors ..... p. 14
- Outdoor walls and windows ..... p. 15
- Outdoor facades ..... p. 16
- Indoor floors ..... p. 17
- Indoor walls ..... p. 18
- Indoor walls and windows ..... p. 19
- Specific protection ..... p. 21
- CHOOSING YOUR SITE PROTECTION: self-adhesive and waterproof tarp ..... p. 22**
- Indoor protection: Dulyfix ..... p. 22
- Indoor protection: Dulycover ..... p. 26
- Indoor protection: DulyPlak, ProtecSol, cotton tarps ..... p. 28
- Masking / adhesives ..... p. 30
- Wipes ..... p. 31
- CHOOSE: your bin bag ..... p. 32**
- Bags ..... p. 32

## 02 PROFESSIONAL CLOTHING

- Customisation and sizes ..... p. 36
- CHOOSE: your clothing range ..... p. 37**
- Evolution Range ..... p. 38
- Performance Range ..... p. 40
- Expert Range ..... p. 42
- Presti-comfort Range ..... p. 46
- Classic Range ..... p. 50
- Sportswear Range ..... p. 52
- Cold Range ..... p. 56
- Complementary Range ..... p. 60
- NEW** Women's Range ..... p. 62
- Rainwear Range ..... p. 64

## 03 PERSONAL PROTECTION

- Disposable clothing ..... p. 66
- Socks ..... p. 67
- CHOOSE: your safety footwear ..... p. 67**
- Safety footwear p. 68
- CHOOSE: your gloves ..... p. 73**
- Hand protection ..... p. 74
- CHOOSE: your single-use mask ..... p. 76**
- Breathing protection ..... p. 77
- Eye protection ..... p. 82
- Head protection ..... p. 84
- Safety products ..... p. 85

## 04 MERCHANDISING

- Complete range ..... p. 86
- Furniture / POS display ..... p. 88



# FAULTLESS PROTECTION FOR PROFESSIONALS

We are proud to be able to offer our customers a wide range of protective plastic films and tarps, made in France and, what's more, from recycled plastic.

We are always seeking to guarantee unique quality and resistance, while reducing our carbon impact, because preserving resources is important to us. Recycled materials, biosourced materials, more sustainable packaging, etc. This is how our commitment to sustainability is reflected in our plastic tarps.

**Dulary plastic tarps are quality! What's more, they are made from recycled plastic, which is even better for the planet!**



Léa  
Buyer  
for a paint  
shop network

# CHOICE GUIDE

## RECYCLED PLASTIC PROTECTIVE TARP

Here you will find all thicknesses of Dulary plastic films and tarps.

A guide to help you identify the product you need throughout the catalogue.

	BIO SOURCED	THICKNESS	PROTECTION LEVEL
<b>THIN*</b>		10 microns	
<b>BASIC</b>		30 microns	
<b>BASIC PRO</b>		35 microns	
<b>BASIC PLUS</b>		40 microns	
<b>STANDARD</b>		50 microns	
<b>STANDARD PRO</b>		65 microns	
<b>PREMIUM</b>		80 microns	
<b>PREMIUM PRO</b>		110 microns	
<b>PRO 150</b>		150 microns	
<b>EXPERT 200</b>		200 microns	

\* virgin plastic

**3 COLOURS TO CHOOSE FROM:**



NEUTRAL    TINTED    BLACK

**3 AREAS OF PROTECTION:**



- › - from **20 m<sup>2</sup>**
- › - from **75 m<sup>2</sup>**
- › **100 m<sup>2</sup> and more**

# A COMPREHENSIVE RANGE FOR PAINTERS

## 01 SITE PROTECTION

## 02 PROFESSIONAL CLOTHING

## 03 PERSONAL PROTECTION

DULYTAPE®  
Adhesive strip  
↳ p.30

Indoor window  
protective  
plastic tarp  
↳ p.19

Indoor floor  
protective  
plastic tarp  
↳ p.17

'Expert'  
Gilet  
↳ p.45

T-shirt  
↳ p.61

Women's  
t-shirt  
↳ p.63

'Expert'  
trousers  
↳ p.43

Hallo  
Trainer  
↳ p.69

Grip & Flex  
Gloves  
↳ p.73

Women's  
'Expert'  
trousers  
↳ p.63

Alice  
Trainer  
↳ p.69



# OUR SUSTAINABLE COMMITMENTS

**While remaining competitive and attractive, our company stands out and is committed to a strong CSR<sup>(1)</sup>/ESG<sup>(2)</sup> approach**

to meet the expectations of its customers and suppliers, who attach increasing importance to social, societal and environmental issues.

**A real challenge to make a positive impact on the environment.**

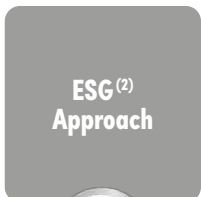
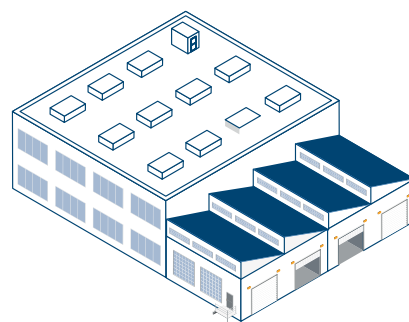

**Reduction of our CO<sub>2</sub> emissions**

Products made exclusively from **recycled plastic** (see MORE label) and/or **biosourced plastic**

**More sustainable packaging**

**30% minimum** of RRM<sup>(3)</sup> in packaging  
**100% recyclable** packaging (LDPE<sup>(4)</sup>)

**Development of a biosourced range**

Biosourced & recycled **plastic tarps**

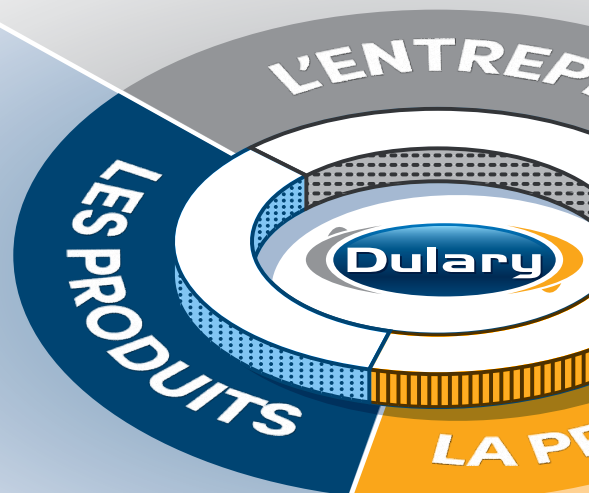

**Recovery of our production waste**

**100%** of our waste is recycled and reintegrated into our production

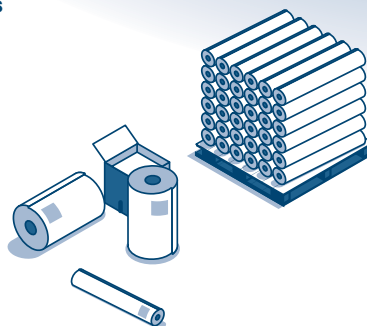

(1) CSR: Corporate Social Responsibility,  
(2) ESG: Environmental, Social and Governance,  
(3) RRM: Recycled Raw Materials  
(4) LDPE: Low Density Polyethylene,  
(5) AWCE: Anti-waste for a Circular Economy,  
(6) ERP: Extended Producer Responsibility,  
(7) CPMB: Construction products and materials for building



**Compliance with regulations**

**Low-carbon trajectory**

**Customer satisfaction objective**

**AWCE<sup>(5)</sup> compliance**  
EPR **COMPLIANCE<sup>(6)</sup>**  
CPMB building<sup>(7)</sup>

**Use of recycled raw materials in packaging**  
  
**Raising awareness and training staff in climate issues:**  
Climate Fresco

**Customer satisfaction rate:**  
**0**  
**Non-compliance in 2022 on plastic films and tarps made in France**

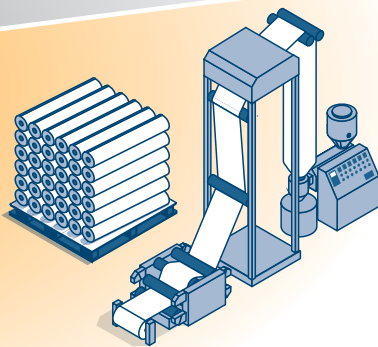
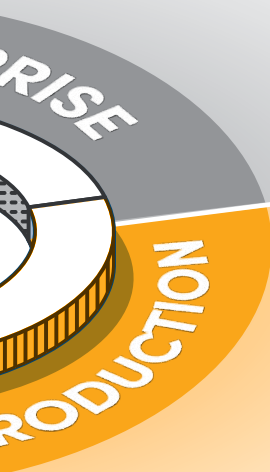

**Plan to reduce energy consumption**

**Decree on the management of pellet losses in the environment**

**French production**

**100% LED**  
**Heat recovery** for heating and sanitary applications

**100% compliance**

**1 production site in FRANCE,** in the Haute Loire, a bastion of the French plastics industry

# OUR VALUES TO PROTECT YOU BETTER

## 01 QUALITY SUPERIOR

Offering you a **constant level of quality** in our products and services is the Dulary commitment to superior quality. Our integrated quality department has implemented a **strict control process** as well as a **continuous improvement approach**. Your peace of mind is our priority.

## 02 SERVICE MORE

At Dulary, **customer services is in our genes**. And customer service means first of all listening, availability and proximity. Because each customer is unique, we are committed to always finding the right turnkey solution. For a more personalised service.

## 03 VALUE ADDED

**Innovation is a priority for us**. Our R&D unit is attentive to needs and trends to offer the most **technical, ergonomic, safe and aesthetic protection solutions**. We also want to provide maximum **added value to our distributors** in terms of sales support: packaging, POS, merchandising, etc.

## 04 HIGH TRUST

The **loyalty of our customers is essential** to us and we do everything to deserve it. Since our inception, we have been committed to the **values of consideration, fairness and respect**, both with our customers, our suppliers and our employees. Highly loyal values that have endured over the years.



# ALL OUR SOLUTIONS FOR ALL YOUR RENOVATION PROJECTS

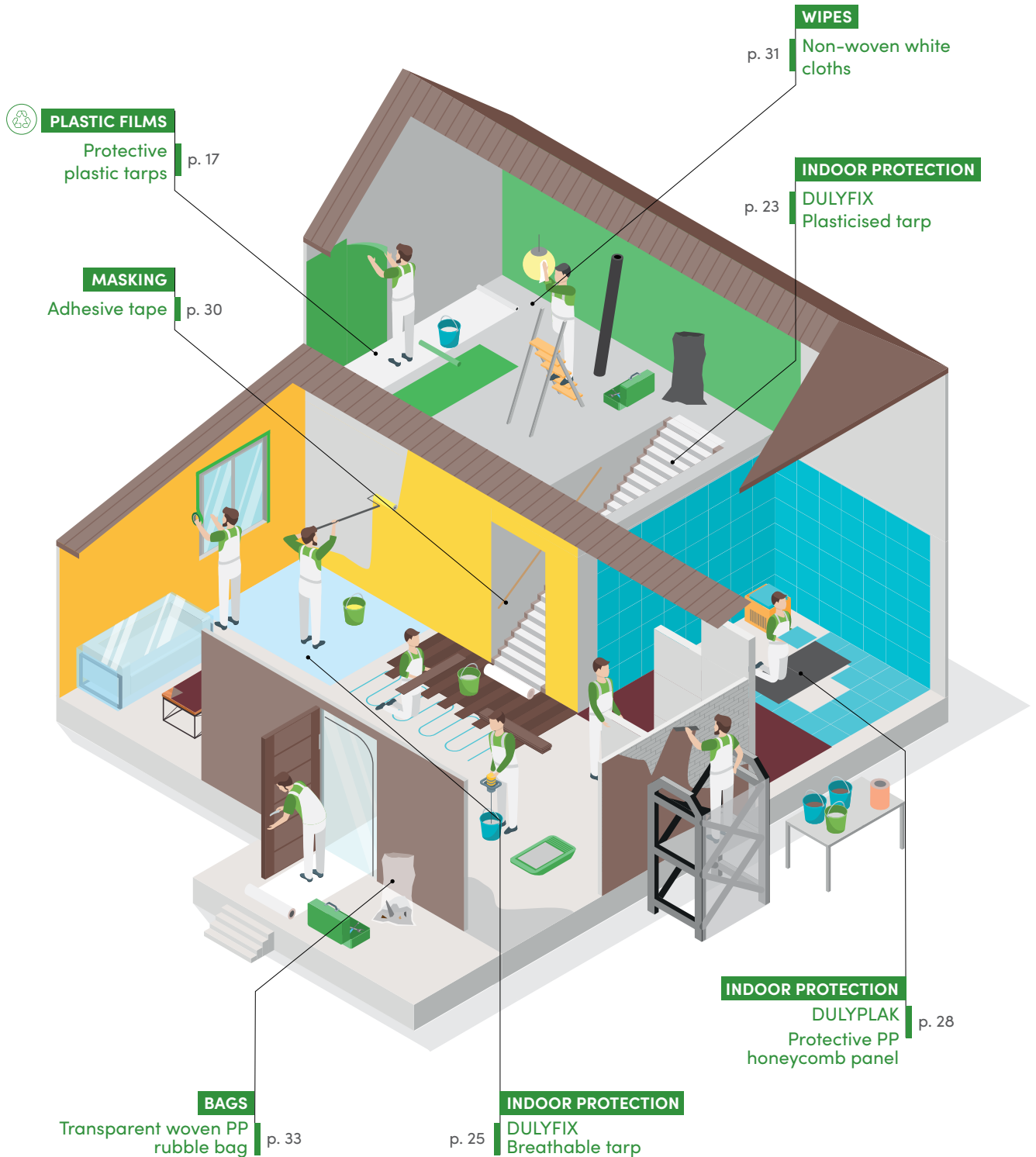





**EXPERTISE  
AT YOUR SERVICE  
TO PROTECT SITES  
AND PEOPLE**

# 01 SITE PROTECTION

Plastic tarp ..... p. 10

**CHOOSING YOUR SITE PROTECTION:  
plastic tarp ..... p. 12**

Outdoor floors ..... p. 14

Outdoor walls and windows ..... p. 15

Outdoor facades ..... p. 16

Indoor floors ..... p. 17

Indoor walls ..... p. 18

Indoor walls and windows ..... p. 19

Specific protection ..... p. 21

**CHOOSING YOUR SITE PROTECTION:  
self-adhesive and waterproof tarp ..... p. 22**

Indoor protection : Dulyfix ..... p. 22

Indoor protection : Dulycover ..... p. 26

Indoor protection:  
DulyPlak, ProtecSol, cotton tarps ..... p. 28

Masking / adhesives ..... p. 30

Wipes ..... p. 31

**CHOOSE:  
your bin bag ..... p. 32**

Bags ..... p. 32

# DULARY, A PIONEER IN PLASTIC TARP RECYCLED AND RECYCLABLE

Keen to promote the development of the circular economy, we were a pioneer in this field, offering **a range of recycled plastic films and tarps right from the start**. Today, **our plastic rolls and reels are made from recycled plastic and are recyclable**.

In order to guarantee high quality films, we are particularly demanding in the selection of recycled raw materials. Thanks to the process of **tri-layer technology** (the thickness of a film is composed of 3 superimposed layers), our films have **a resistance to tearing and perforation**.



The **MORE 2022** label, which promotes the use of recycled raw materials, has been awarded to our plastic film production.



## Dulybio

### BIOSOURCED FILM, ANOTHER STEP IN OUR ENVIRONMENTALLY RESPONSIBLE APPROACH

As part of our innovation, we are proud to offer you a plastic film **made from plant-based material with a patent pending**. For the manufacture of this new DULYBIO biosourced range, we have selected a natural material : **sugar cane bagasse**. With this new biosourced range, Dulary enriches its film offering, still as resistant, and contributes to the reduction in CO<sub>2</sub>.

#### Why sugar cane bagasse?

Bagasse is the fibrous residue from the crushing of sugar cane. It is one of the best natural alternatives to virgin plastic. An ideal eco-friendly material that contributes to the development of the circular economy, guaranteeing a film that is as strong as virgin or recycled plastic film.



LESS CO<sub>2</sub> EMISSIONS



## OUR COMMITMENTS



MADE IN FRANCE



RECYCLED



RECYCLABLE

## OUR 'PLUS' PRODUCT



TRI-LAYER FILM

OPTIMAL RESISTANCE



NON-SLIP



ODOURLESS



## 3 FORMATS

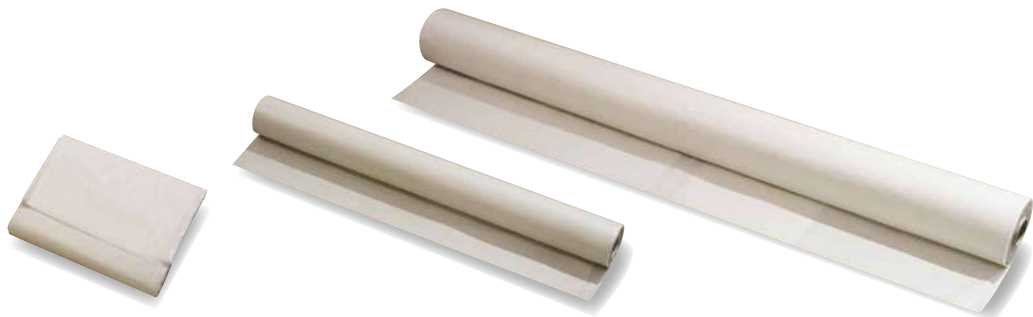

### FOLDED POLYETHYLENE TARP

AREA TO PROTECT  
- from **20 m<sup>2</sup>**

Ready-to-use pre-cut tarp. Format suitable for **work on small areas.**

### REEL

AREA TO PROTECT  
- from **75 m<sup>2</sup>**

The **practical** roll par excellence, easy to transport, unrolls and unfolds to a width of 3 m.

### LARGE ROLLER

AREA TO PROTECT  
**100 m<sup>2</sup> and more**

Ideal for protecting **very large areas.** Available in 3 m or 6 m roll widths.



CHOOSING  
**YOUR PROTECTIVE PLASTIC TARP:**

→ SEE P. 12

# CHOOSE PROTECTIVE PLASTIC TARP

**With Dulary: the right tarp for every situation!**

To make the right choice of plastic tarp, all you need to do is identify the site environment and what you need to protect:

- Indoor or outdoor?
- During "heavy" work that generates a lot of dust - such as sanding or paint finishing?
- Floor or vertical areas?
- For several weeks or a short period?

Use the table below to find the right tarp for you!



 <b>TEMPORARY OUTDOOR PROTECTION</b>	 <b>TEMPORARY INDOOR PROTECTION</b>
<b>FLOORS</b>	<b>WALLS AND WINDOWS</b>
	
	<b>FLOORS</b>
	

 <b>SITE PREPARATION</b>	<table border="1"> <tr><td>LIGHTWEIGHT</td></tr> <tr><td>BASIC</td><td>BASIC PRO</td></tr> <tr><td>BASIC PLUS</td><td>STANDARD</td></tr> <tr><td>STANDARD PRO</td><td>PREMIUM</td></tr> <tr><td>PREMIUM PRO</td><td>PRO 150</td><td>EXPERT 200</td></tr> </table>	LIGHTWEIGHT	BASIC	BASIC PRO	BASIC PLUS	STANDARD	STANDARD PRO	PREMIUM	PREMIUM PRO	PRO 150	EXPERT 200	<table border="1"> <tr><td>LIGHTWEIGHT</td></tr> <tr><td>BASIC</td><td>BASIC PRO</td></tr> <tr><td>BASIC PLUS</td><td>STANDARD</td></tr> <tr><td>STANDARD PRO</td><td>PREMIUM</td></tr> <tr><td>PREMIUM PRO</td><td>PRO 150</td><td>EXPERT 200</td></tr> </table>	LIGHTWEIGHT	BASIC	BASIC PRO	BASIC PLUS	STANDARD	STANDARD PRO	PREMIUM	PREMIUM PRO	PRO 150	EXPERT 200	<table border="1"> <tr><td>LIGHTWEIGHT</td></tr> <tr><td>BASIC</td><td>BASIC PRO</td></tr> <tr><td>BASIC PLUS</td><td>STANDARD</td></tr> <tr><td>STANDARD PRO</td><td>PREMIUM</td></tr> <tr><td>PREMIUM PRO</td><td>PRO 150</td><td>EXPERT 200</td></tr> </table>	LIGHTWEIGHT	BASIC	BASIC PRO	BASIC PLUS	STANDARD	STANDARD PRO	PREMIUM	PREMIUM PRO	PRO 150	EXPERT 200
LIGHTWEIGHT																																	
BASIC	BASIC PRO																																
BASIC PLUS	STANDARD																																
STANDARD PRO	PREMIUM																																
PREMIUM PRO	PRO 150	EXPERT 200																															
LIGHTWEIGHT																																	
BASIC	BASIC PRO																																
BASIC PLUS	STANDARD																																
STANDARD PRO	PREMIUM																																
PREMIUM PRO	PRO 150	EXPERT 200																															
LIGHTWEIGHT																																	
BASIC	BASIC PRO																																
BASIC PLUS	STANDARD																																
STANDARD PRO	PREMIUM																																
PREMIUM PRO	PRO 150	EXPERT 200																															
 <b>PAINT &amp; FINISHING</b>	<table border="1"> <tr><td>LIGHTWEIGHT</td></tr> <tr><td>BASIC</td><td>BASIC PRO</td></tr> <tr><td>BASIC PLUS</td><td>STANDARD</td></tr> <tr><td>STANDARD PRO</td><td>PREMIUM</td></tr> <tr><td>PREMIUM PRO</td><td>PRO 150</td><td>EXPERT 200</td></tr> </table>	LIGHTWEIGHT	BASIC	BASIC PRO	BASIC PLUS	STANDARD	STANDARD PRO	PREMIUM	PREMIUM PRO	PRO 150	EXPERT 200	<table border="1"> <tr><td>LIGHTWEIGHT</td></tr> <tr><td>BASIC</td><td>BASIC PRO</td></tr> <tr><td>BASIC PLUS</td><td>STANDARD</td></tr> <tr><td>STANDARD PRO</td><td>PREMIUM</td></tr> <tr><td>PREMIUM PRO</td><td>PRO 150</td><td>EXPERT 200</td></tr> </table>	LIGHTWEIGHT	BASIC	BASIC PRO	BASIC PLUS	STANDARD	STANDARD PRO	PREMIUM	PREMIUM PRO	PRO 150	EXPERT 200	<table border="1"> <tr><td>LIGHTWEIGHT</td></tr> <tr><td>BASIC</td><td>BASIC PRO</td></tr> <tr><td>BASIC PLUS</td><td>STANDARD</td></tr> <tr><td>STANDARD PRO</td><td>PREMIUM</td></tr> <tr><td>PREMIUM PRO</td><td>PRO 150</td><td>EXPERT 200</td></tr> </table>	LIGHTWEIGHT	BASIC	BASIC PRO	BASIC PLUS	STANDARD	STANDARD PRO	PREMIUM	PREMIUM PRO	PRO 150	EXPERT 200
LIGHTWEIGHT																																	
BASIC	BASIC PRO																																
BASIC PLUS	STANDARD																																
STANDARD PRO	PREMIUM																																
PREMIUM PRO	PRO 150	EXPERT 200																															
LIGHTWEIGHT																																	
BASIC	BASIC PRO																																
BASIC PLUS	STANDARD																																
STANDARD PRO	PREMIUM																																
PREMIUM PRO	PRO 150	EXPERT 200																															
LIGHTWEIGHT																																	
BASIC	BASIC PRO																																
BASIC PLUS	STANDARD																																
STANDARD PRO	PREMIUM																																
PREMIUM PRO	PRO 150	EXPERT 200																															
 <b>SPECIFIC PROTECTION</b>																																	
<b>PAGE</b>	p. 14	p. 15	p. 17																														



TEMPORARY INDOOR PROTECTION

SPECIFIC PROTECTION

PERMANENT PROTECTION

WALLS

FURNITURE AND WINDOWS

FIRE-RETARDANT PROTECTION

UNDER-PAVING & UNDER-PARQUETING



LIGHTWEIGHT		
BASIC	BASIC PRO	
BASIC PLUS	STANDARD	
STANDARD PRO	PREMIUM	
PREMIUM PRO	PRO 150	EXPERT 200

LIGHTWEIGHT		
BASIC	BASIC PRO	
BASIC PLUS	STANDARD	
STANDARD PRO	PREMIUM	
PREMIUM PRO	PRO 150	EXPERT 200

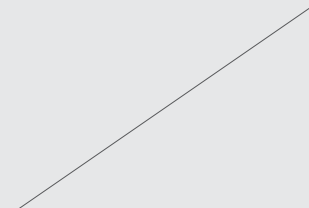

LIGHTWEIGHT		
BASIC	BASIC PRO	
BASIC PLUS	STANDARD	
STANDARD PRO	PREMIUM	
PREMIUM PRO	PRO 150	EXPERT 200

LIGHTWEIGHT		
BASIC	BASIC PRO	
BASIC PLUS	STANDARD	
STANDARD PRO	PREMIUM	
PREMIUM PRO	PRO 150	EXPERT 200



114 BLACK    200 WHITE

100



SITE PROTECTION

# TEMPORARY OUTDOOR PROTECTION

## FLOORS

### Reel



- from 75 m<sup>2</sup>

QUALITY	SITE PREPARATION	PAINT/ FINISHING	DIMENSIONS	M <sup>2</sup>	COLOUR	FOLDED IN	QTY / PALLET	REF.
BASIC PLUS			3 m x 25 m	75	neutral	4	203	10 05 20
STANDARD			3 m x 25 m	75	neutral	4	150	10 05 30
STANDARD PRO			3 m x 25 m	75	neutral	4	126	10 05 35 <b>NEW</b>
PREMIUM			3 m x 25 m	75	neutral	4	105	10 05 40
PREMIUM PRO			3 m x 25 m	75	neutral	4	68	10 05 60 <b>NEW</b>
PRO 150			3 m x 25 m	75	neutral	4	60	10 05 70



### Roll / Construction roll



100 m<sup>2</sup> and more

QUALITY	SITE PREPARATION	PAINT/ FINISHING	DIMENSIONS	M <sup>2</sup>	COLOUR	FOLDED IN	QTY / PALLET	REF.
STANDARD			3 m x 50 m	150	neutral	4	86	10 10 30
			3 m x 50 m	150	tinted	4	86	10 10 35
			3 m x 100 m	300	neutral	2	39	10 10 70
			6 m x 25 m	150	neutral	4	53	10 15 30
			6 m x 40 m	240	tinted	4	52	10 15 35
			6 m x 27.50 m	165	tinted	4	52	10 15 65
STANDARD PRO			3 m x 50 m	150	neutral	4	60	10 10 50
PREMIUM			3 m x 25 m	75	neutral	2	59	10 20 10
			3 m x 50 m	150	neutral	2	44	10 20 20
PRO 150			3 m x 50 m	150	tinted	2	44	10 20 30
			3 m x 50 m	150	neutral	4	33	10 20 40
			3 m x 50 m	150	tinted	4	44	10 20 50
			6 m x 25 m	150	neutral	4	44	10 20 60
			3 m x 50 m	150	black	2	44	10 30 20
			6 m x 25 m	150	black	4	44	10 30 25
EXPERT 200			3 m x 41 m	123	neutral	2	44	10 25 20
			6 m x 20.5 m	123	neutral	4	44	10 25 30



DULARY ADVICE

For both indoor and outdoor, use **Dulytape®** to attach your tarps.

Find out more about Dulytape® page 30



# TEMPORARY **OUTDOOR** PROTECTION

## WALLS AND WINDOWS

SITE PROTECTION

01

### Folded tarp



- from 20 m<sup>2</sup>

QUALITY	SITE PREPARATION	PAINT/ FINISHING	DIMENSIONS	QTY / BOX	REF.
STANDARD			5 m x 4 m	15	10 65 15
PREMIUM			4 m x 3 m	10	10 65 20
			5 m x 4 m	10	10 65 25



### Bobineau roll



- from 75 m<sup>2</sup>

QUALITY	SITE PREPARATION	PAINT/ FINISHING	DIMENSIONS	M <sup>2</sup>	COLOUR	FOLDED IN	QTY / PALLET	REF.
BASIC PLUS			3 m x 25 m	75	neutral	4	203	10 05 20
STANDARD			3 m x 25 m	75	neutral	4	150	10 05 30
STANDARD PRO			3 m x 25 m	75	neutral	4	126	10 05 35 <b>NEW</b>
PREMIUM			3 m x 25 m	75	neutral	4	105	10 05 40
PREMIUM PRO			3 m x 25 m	75	neutral	4	68	10 05 60 <b>NEW</b>
PRO 150			3 m x 25 m	75	neutral	4	60	10 05 70



### Roll / Construction roll



100 m<sup>2</sup> and more

QUALITY	SITE PREPARATION	PAINT/ FINISHING	DIMENSIONS	M <sup>2</sup>	COLOUR	FOLDED IN	QTY / PALLET	REF.
STANDARD			3 m x 50 m	150	neutral	4	86	10 10 30
			3 m x 50 m	150	tinted	4	86	10 10 35
			3 m x 100 m	300	neutral	2	39	10 10 70
			6 m x 25 m	150	neutral	4	53	10 15 30
			6 m x 40 m	240	tinted	4	52	10 15 35
STANDARD PRO			6 m x 27.50 m	165	tinted	4	52	10 15 65
PREMIUM			3 m x 50 m	150	neutral	4	60	10 10 50
PRO 150			3 m x 25 m	75	neutral	2	59	10 20 10
			3 m x 50 m	150	neutral	2	44	10 20 20
			3 m x 50 m	150	tinted	2	44	10 20 30
	3 m x 50 m	150	neutral	4	33	10 20 40		
	3 m x 50 m	150	tinted	4	44	10 20 50		
	6 m x 25 m	150	neutral	4	44	10 20 60		
	3 m x 50 m	150	black	2	44	10 30 20		
	6 m x 25 m	150	black	4	44	10 30 25		
	EXPERT 200	3 m x 41 m	123	neutral	2	44	10 25 20	
	6 m x 20.5 m	123	neutral	4	44	10 25 30		



SITE PROTECTION

## SPECIFIC PROTECTION

## OUTDOOR FACADES

## Heavy-duty polyethylene tarp

DIMENSIONS	WHITE/CLEAR	GREEN
6 m x 4 m	13 10 20	-
8 m x 6 m	13 10 30	13 15 30
20 m x 3.10 m	13 10 50	-

> 150 g/m<sup>2</sup> with metal anchor points every metre, eyelets on 4 sides.

## ADVANTAGES

Highly resistant weave.  
Structure enables cutting.



## Reinforced polyethylene tarp

Ref. 13 20 10

> 130 g/m<sup>2</sup> with pre-perforated eyelet reinforcement strips every 20 cm.  
> Dimensions: 20 m x 3.20 m.  
> See-through with white grid.

## ADVANTAGES

Ideal for use with plaster-like splashes.  
Airtight.

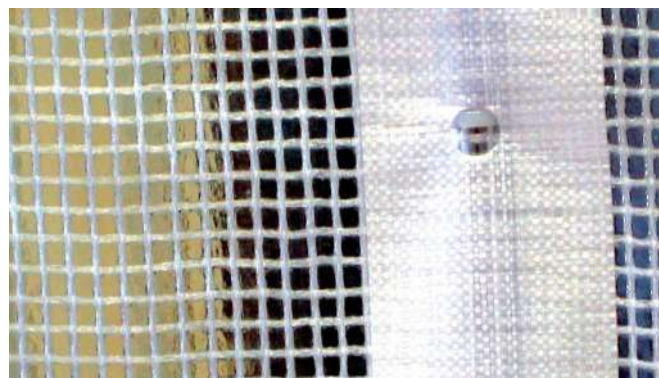

## Scaffold mesh

White: ref. 13 30 15- green: ref. 13 30 10

Dimensions: 20 m x 3 m  
55 g/m<sup>2</sup>. Non anti-UV treated.

## ADVANTAGES

Run-resistant mesh.

## Fasteners

	DIMENSIONS	REF.
For meshes:	Small model L. 290 mm x W. 4.8 mm	13 40 10
For tarps:	Large model L. 365 mm x W. 7.8 mm	13 40 15

Plastic fastener links. Packs of 100.





# TEMPORARY INDOOR PROTECTION FLOORS

SITE PROTECTION

01

**FLOORS**

## Folded tarp



- from 20 m<sup>2</sup>

QUALITY	SITE PREPARATION	PAINT/ FINISHING	DIMENSIONS	QTY / box	REF.
STANDARD			5 m x 4 m	15	10 65 15
PREMIUM			4 m x 3 m	10	10 65 20
			5 m x 4 m	10	10 65 25



## Bobineau roll



- from 75 m<sup>2</sup>

QUALITY	SITE PREPARATION	PAINT/ FINISHING	DIMENSIONS	M <sup>2</sup>	COLOUR	FOLDED IN	QTY / PALLET	REF.	
BASIC PRO			3 m x 25 m	75	neutral	4	203	10 05 15	NEW
BASIC PRO			3 m x 25 m	75	neutral	4	203	10 40 20	
BASIC PLUS			3 m x 25 m	75	neutral	4	203	10 05 20	
STANDARD			3 m x 25 m	75	neutral	4	150	10 05 30	
STANDARD PRO			3 m x 25 m	75	neutral	4	126	10 05 35	NEW
PREMIUM			3 m x 25 m	75	neutral	4	105	10 05 40	
PREMIUM PRO			3 m x 25 m	75	neutral	4	68	10 05 60	NEW
PRO 150			3 m x 25 m	75	neutral	4	60	10 05 70	



## Roll / Construction roll



100 m<sup>2</sup> and more

QUALITY	SITE PREPARATION	PAINT/ FINISHING	DIMENSIONS	M <sup>2</sup>	COLOUR	FOLDED IN	QTY / PALLET	REF.
STANDARD			3 m x 50 m	150	neutral	4	86	10 10 30
			3 m x 50 m	150	tinted	4	86	10 10 35
			3 m x 100 m	300	neutral	2	39	10 10 70
			6 m x 25 m	150	neutral	4	53	10 15 30
			6 m x 40 m	240	tinted	4	52	10 15 35
STANDARD PRO			6 m x 27.50 m	165	tinted	4	52	10 15 65
PREMIUM			3 m x 50 m	150	neutral	4	60	10 10 50
PRO 150			3 m x 25 m	75	neutral	2	59	10 20 10
			3 m x 50 m	150	neutral	2	44	10 20 20
			3 m x 50 m	150	tinted	2	44	10 20 30
			3 m x 50 m	150	neutral	4	33	10 20 40
			3 m x 50 m	150	tinted	4	44	10 20 50
			6 m x 25 m	150	neutral	4	44	10 20 60
			3 m x 50 m	150	black	2	44	10 30 20
			6 m x 25 m	150	black	4	44	10 30 25
			3 m x 41 m	123	neutral	2	44	10 25 20
			6 m x 20.5 m	123	neutral	4	44	10 25 30





SITE PROTECTION

# TEMPORARY INDOOR PROTECTION

## WALLS

- from 20 m<sup>2</sup>

### Folded tarp

QUALITY	SITE PREPARATION	PAINT/ FINISHING	DIMENSIONS	QTY / box	REF.
STANDARD			5 m x 4 m	15	10 65 15
PREMIUM			4 m x 3 m	10	10 65 20
			5 m x 4 m	10	10 65 25



- from 75 m<sup>2</sup>

### Bobineau roll

QUALITY	SITE PREPARATION	PAINT/ FINISHING	DIMENSIONS	M <sup>2</sup>	COLOUR	FOLDED IN	QTY / PALLET	REF.	
BASIC			3 m x 25 m	75	neutral	4	202	10 05 10	
BASIC PRO			3 m x 25 m	75	neutral	4	203	10 05 15	NEW
BASIC PRO			3 m x 25 m	75	neutral	4	203	10 40 20	
BASIC PLUS			3 m x 25 m	75	neutral	4	203	10 05 20	
STANDARD			3 m x 25 m	75	neutral	4	150	10 05 30	
STANDARD PRO			3 m x 25 m	75	neutral	4	126	10 05 35	NEW
PREMIUM			3 m x 25 m	75	neutral	4	105	10 05 40	
PREMIUM PRO			3 m x 25 m	75	neutral	4	68	10 05 60	NEW
PRD 150			3 m x 25 m	75	neutral	4	60	10 05 70	



100 m<sup>2</sup> and more

### Roll / Construction roll

QUALITY	SITE PREPARATION	PAINT/ FINISHING	DIMENSIONS	M <sup>2</sup>	COLOUR	FOLDED IN	QTY / PALLET	REF.
BASIC			6 m x 50 m	300	neutral	4	52	10 15 10
STANDARD			3 m x 50 m	150	neutral	4	86	10 10 30
			3 m x 50 m	150	tinted	4	86	10 10 35
			3 m x 100 m	300	neutral	2	39	10 10 70
PRD 150			6 m x 25 m	150	neutral	4	53	10 15 30
			6 m x 40 m	240	tinted	4	52	10 15 35
			6 m x 27,50 m	165	tinted	4	52	10 15 65
			3 m x 50 m	150	neutral	4	60	10 10 50
			3 m x 25 m	75	neutral	2	59	10 20 10
			3 m x 50 m	150	neutral	2	44	10 20 20
	3 m x 50 m	150	tinted	2	44	10 20 30		
	3 m x 50 m	150	neutral	4	33	10 20 40		
3 m x 50 m	150	tinted	4	44	10 20 50			
PRD 150	6 m x 25 m	150	neutral	4	44	10 20 60		
	3 m x 50 m	150	black	2	44	10 30 20		
	6 m x 25 m	150	black	4	44	10 30 25		



# TEMPORARY INDOOR PROTECTION

SITE PROTECTION

## FURNITURE AND WINDOWS

01

- from 20 m<sup>2</sup>

### Folded tarp

QUALITY	SITE PREPARATION	PAINT/FINISHING	DIMENSIONS	QTY / box	REF.
THIN		✓	5 m x 4 m	40	10 65 10
THIN		✓	4 m x 3 m	60	10 40 05
STANDARD			5 m x 4 m	15	10 65 15
PREMIUM	✓		4 m x 3 m	10	10 65 20
			5 m x 4 m	10	10 65 25



- from 75 m<sup>2</sup>

### Bobineau roll

QUALITY	SITE PREPARATION	PAINT/FINISHING	DIMENSIONS	M <sup>2</sup>	COLOUR	FOLDED IN	QTY / PALLET	REF.
BASIC			3 m x 25 m	75	neutral	4	202	10 05 10
BASIC PRO		✓	3 m x 25 m	75	neutral	4	203	10 05 15 <b>NEW</b>
BASIC PRO			3 m x 25 m	75	neutral	4	203	10 40 20
BASIC PLUS			3 m x 25 m	75	neutral	4	203	10 05 20
STANDARD	✓		3 m x 25 m	75	neutral	4	150	10 05 30
STANDARD PRO			3 m x 25 m	75	neutral	4	126	10 05 35 <b>NEW</b>
PREMIUM			3 m x 25 m	75	neutral	4	105	10 05 40
PREMIUM PRO			3 m x 25 m	75	neutral	4	68	10 05 60 <b>NEW</b>
PRO 150			3 m x 25 m	75	neutral	4	60	10 05 70



100 m<sup>2</sup> and more

### Roll / Construction roll

QUALITY	SITE PREPARATION	PAINT/FINISHING	DIMENSIONS	M <sup>2</sup>	COLOUR	FOLDED IN	QTY / PALLET	REF.
BASIC		✓	6 m x 50 m	300	neutral	4	52	10 15 10
STANDARD			3 m x 50 m	150	neutral	4	86	10 10 30
			3 m x 50 m	150	tinted	4	86	10 10 35
			3 m x 100 m	300	neutral	2	39	10 10 70
			6 m x 25 m	150	neutral	4	53	10 15 30
			6 m x 40 m	240	tinted	4	52	10 15 35
STANDARD PRO			6 m x 27,50 m	165	tinted	4	52	10 15 65
PREMIUM	✓		3 m x 50 m	150	neutral	4	60	10 10 50
PRO 150			3 m x 25 m	75	neutral	2	59	10 20 10
			3 m x 50 m	150	neutral	2	44	10 20 20
			3 m x 50 m	150	tinted	2	44	10 20 30
			3 m x 50 m	150	neutral	4	33	10 20 40
			3 m x 50 m	150	tinted	4	44	10 20 50
			6 m x 25 m	150	neutral	4	44	10 20 60
			3 m x 50 m	150	black	2	44	10 30 20
			6 m x 25 m	150	black	4	44	10 30 25





SITE PROTECTION

# PLASTIC TARPS TEMPORARY PROTECTION



Here you will find our full range of recycled and recyclable plastic films and tarps to protect your sites.

**Recycled and biosourced tarps**

	DIMENSIONS	M <sup>2</sup>	QTY /	REF.
Dulybio.P2	4 m x 3 m	12	Box 60	<b>10 40 05</b>
Dulybio.B4	3 m x 25 m	75	Pallet 203	<b>10 40 20</b>

## Folded polyethylene tarps

QUALITY	DIMENSIONS	QTY / BOX	REF.
Thin*	5 m x 4 m	40	<b>10 65 10</b>
Dulybio.P2	4 m x 3 m	60	<b>10 40 05</b>
Standard	5 m x 4 m	15	<b>10 65 15</b>
Premium	4 m x 3 m	10	<b>10 65 20</b>
	5 m x 4 m	10	<b>10 65 25</b>

## Reels

QUALITY	DIMENSIONS	M <sup>2</sup>	COLOUR	FOLDED IN	QTY / PALLET	REF.
Basic	3 m x 25 m	75	neutral	4	202	<b>10 05 10</b>
Basic Pro	3 m x 25 m	75	neutral	4	203	<b>10 05 15</b>
Dulybio.B4	3 m x 25 m	75	neutral	4	203	<b>10 40 20</b>
Basic plus	3 m x 25 m	75	neutral	4	203	<b>10 05 20</b>
Standard	3 m x 25 m	75	neutral	4	150	<b>10 05 30</b>
Standard Pro	3 m x 25 m	75	neutral	4	126	<b>10 05 35</b>
Premium	3 m x 25 m	75	neutral	4	105	<b>10 05 40</b>
Premium Pro	3 m x 25 m	75	neutral	4	60	<b>10 05 60</b>
Pro 150	3 m x 25 m	75	neutral	4	60	<b>10 05 70</b>

## Rolls

QUALITY	DIMENSIONS	M <sup>2</sup>	COLOUR	FOLDED IN	QTY / PALLET	REF.
Standard	3 m x 50 m	150	neutral	4	86	<b>10 10 30</b>
Standard	3 m x 50 m	150	tinted	4	86	<b>10 10 35</b>
Premium	3 m x 50 m	150	neutral	4	60	<b>10 10 50</b>
Standard	3 m x 100 m	300	neutral	2	39	<b>10 10 70</b>
Basic	6 m x 50 m	300	neutral	4	52	<b>10 15 10</b>
Standard	6 m x 25 m	150	neutral	4	53	<b>10 15 30</b>
Standard	6 m x 40 m	240	tinted	4	52	<b>10 15 35</b>
Standard +	6 m x 27.50 m	165	tinted	4	52	<b>10 15 65</b>

## Construction rolls

QUALITY	DIMENSIONS	M <sup>2</sup>	COLOUR	FOLDED IN	QTY / PALLET	REF.
Pro 150	3 m x 25 m	75	neutral	2	59	<b>10 20 10</b>
Pro 150	3 m x 50 m	150	tinted	2	44	<b>10 20 20</b>
Pro 150	3 m x 50 m	150	neutral	2	44	<b>10 20 30</b>
Pro 150	3 m x 50 m	300	neutral	4	33	<b>10 20 40</b>
Pro 150	3 m x 50 m	300	neutral	4	44	<b>10 20 50</b>
Pro 150	6 m x 25 m	150	neutral	4	44	<b>10 20 60</b>
Pro 150	3 m x 50 m	150	neutral	2	44	<b>10 30 20</b>
Pro 150	6 m x 25 m	150	neutral	4	44	<b>10 30 25</b>
Expert 200	3 m x 41 m	123	tinted	2	44	<b>10 25 20</b>
Expert 200	6 m x 20.5 m	123	tinted	4	44	<b>10 25 30</b>

\* virgin plastic

## TEMPORARY PROTECTION

**POLYETHYLENE FILMS TO STOP FLAMES SPREADING**  
 for occupied sites or PUBLIC BUILDINGS

NF P92-512:1986 standard  
 Reaction to fire:  
 non-flammable fuel



### Fire-retardant PE film M1 classified

DIMENSIONS	COLOUR	THICKNESS	AREA	REF.
6 m x 40 m	opaque black	114 microns	approx. 240 m <sup>2</sup>	<b>10 50 10</b>
6 m x 43 m	opaque white	200 microns	approx. 258 m <sup>2</sup>	<b>10 50 11</b>



- Flame-retardant polyethylene film, M1 classified.
- › Prevents the spread of flames in the event of a fire
  - › Resistant

## Protective zip door

DIMENSIONS	SALES UNIT	REF.
2.2 m x 1.2 m	Individually or box of 11 doors	<b>10 62 10</b>

- PE protective tarp with zipped door
- › Prevents the transfer of dust from one room to another while providing quick access
  - › Stitched closure
  - › Reclosable
  - › L-shaped opening: easy access without stepping over
  - › Durable and reusable
  - › Sold without adhesive



ANTI-DUST



THICK  
AND EXTREMELY  
DURABLE



QUICK  
AND EASY  
TO INSTALL



REUSABLE



## PERMANENT PROTECTION

### Laminated parquet underlay



Ref. **10 60 30**

Dimensions: 4 x 10 m





- › 100 microns thickness.
- › Sold individually or in a pallet of 39 rolls.



## CHOOSING YOUR SELF-ADHESIVE WATERPROOF TARP:

# Dulyfix

A range adapted to the protection requirements

FLOOR TYPE	MECHANICAL LOADS (TRAFFIC)	SELF-ADHESIVE TARP SOLUTION	WEIGHT	DIMENSIONS	UPSELL
Specific floors: porous, freshly laid	 Moderate to heavy	<b>Dulyfix</b> RESPIRANTE	160 g/m <sup>2</sup>	1 m x 25 m	★★★
Non-porous floors	 Heavy to very heavy	<b>Dulyfix</b> ABSORBANTE	205 g/m <sup>2</sup>	1 m x 12 m 1 m x 25 m	★★★★★
Delicate floors (parquet, laminate, etc.)	 Heavy to very heavy	<b>Dulyfix</b> PLASTIFIÉE PREMIUM	180 g/m <sup>2</sup>	1 m x 25 m	★★★★★
Non-porous hard floors (tiling, carpet)	 Moderate	<b>Dulyfix</b> PLASTIFIÉE	120 g/m <sup>2</sup>	0.65 m x 25 m 1 m x 25 m 1 m x 50 m 2 m x 25 m	★★



50 ANS

Yann  
Painter, South West

### Dulyfix, it's very practical:

It can be cut and laid neatly and cleanly in corners, it's non-slip when walked on, it's absorbent, it sticks to the floor and it's hard-wearing.

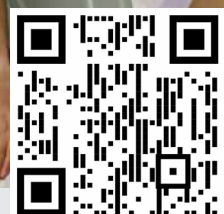

# INDOOR PROTECTION



## A RANGE OF SELF-ADHESIVE AND WATERPROOF TARPS

### Dulyfix PLASTIFIÉE

**Perfect for traditional sites on non-porous hard floors**  
With moderate mechanical loads

Non-woven PET synthetic fibre  
> 1 plasticised top side.  
> 1 self-adhesive underside.

DIMENSIONS	SALES UNIT	USE	WEIGHT	REF.
0.65 m x 25 m	Individually or box of 15 rolls	Small spaces	120 g/m <sup>2</sup>	<b>14 40 05</b>
1 m x 25 m	Individually or box of 15 rolls	Stairs, hallways, standard rooms	120 g/m <sup>2</sup>	<b>14 40 11</b>
1 m x 50 m	Individually or pallet of 15 rolls	Stairs, hallways, long areas	120 g/m <sup>2</sup>	<b>14 40 15</b>
2 m x 25 m	unit	Large rooms	120 g/m <sup>2</sup>	<b>14 40 20</b>

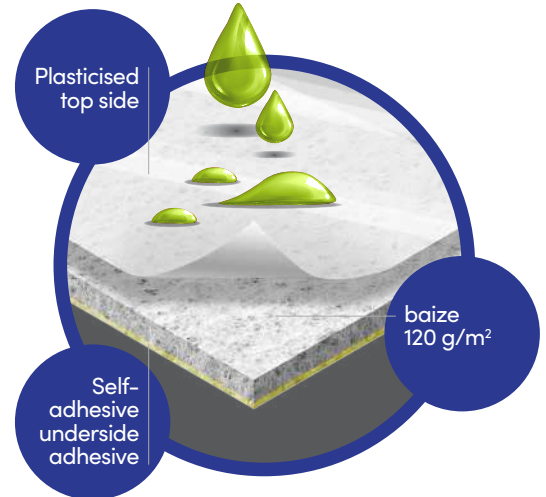

### Dulyfix PLASTIFIÉE PREMIUM

**Perfect for delicate floors (laminated parquets, etc.)**  
with heavy to very heavy mechanical loads

Non-woven PET synthetic fibre  
> 1 plasticised top side.  
> 1 self-adhesive underside.

DIMENSIONS	SALES UNIT	USE	WEIGHT	REF.
1 m x 25 m	Individually or box of 11 rolls	Stairs, hallways, standard rooms	180 g/m <sup>2</sup>	<b>14 40 40</b>

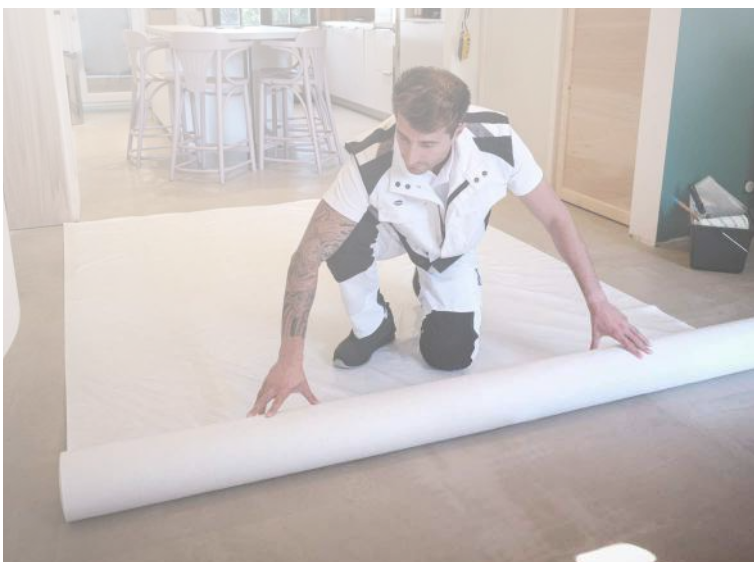
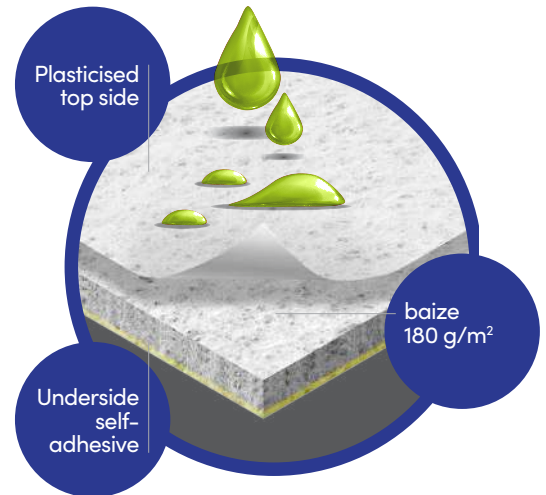

## A RANGE OF SELF-ADHESIVE AND WATERPROOF TARPS

### Dulyfix ABSORBANTE

**Highly absorbent - Impact special  
For non-porous floors**

With heavy to very heavy mechanical loads

Non-woven synthetic - 2.2 mm thickness.

- › 1 absorbent top side.
- › 1 self-adhesive underside.
- › Weight: approx. 205 g/m<sup>2</sup>.

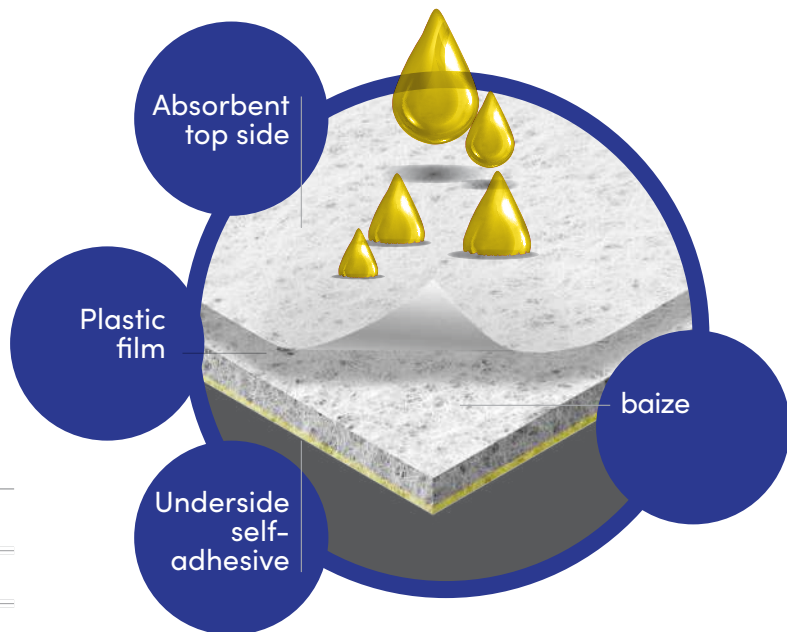

DIMENSIONS	SALES UNIT	REF.
1 m x 12 m	Individually or box of 16 rolls	<b>14 35 10</b>
1 m x 25 m	Individually or pallet of 20 rolls	<b>14 35 15</b>





**A RANGE OF SELF-ADHESIVE AND WATERPROOF TARPS**

**Dulyfix**  
**RESPIRANTE**

Encourages the evaporation of vapours and solvents  
**Perfect for freshly laid floors, moisture-sensitive coverings for specific floors: Porous, freshly laid**  
 With moderate to heavy mechanical loads  
 Provides site protection after only 72 hours of drying.

Non-woven PET synthetic fibre – Thickness: 1.8 mm.  
 › 1 breathable and plasticised top side.  
 › 1 self-adhesive underside. Colour: Blue.  
 › Weight: Approx. 160 g/m<sup>2</sup>.

DIMENSIONS	SALES UNIT	REF.
1 m x 25 m	Individually or box of 12 rolls	<b>14 43 11</b>

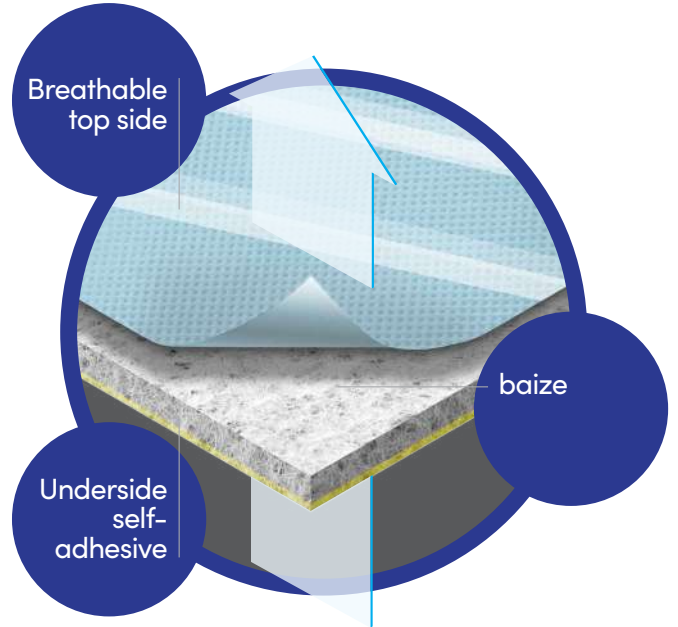

FELT TARP RANGE



# Dulycover

**AIRTIGHT**

**Absorbent airtight felt tarp**

DIMENSIONS	WEIGHT	SALES UNIT	REF.
10 m x 1 m	200 g/m <sup>2</sup>	individually or box of 12 rolls	14 10 10
25 m x 1 m	200 g/m <sup>2</sup>	individually or box of 20 rolls	14 10 15
50 m x 1 m	200 g/m <sup>2</sup>	individually or box of 20 rolls	14 10 30

**Absorbent airtight shockproof felt tarp**

DIMENSIONS	WEIGHT	SALES UNIT	REF.
25 m x 1 m	300 g/m <sup>2</sup>	individually or box of 12 rolls	14 10 50

Made from a 2 mm thick non-woven synthetic material.  
 › 1 absorbent top side.  
 › 1 airtight polyethylene underside of 50 microns thickness.

**ADVANTAGES**

Efficient liquid absorption.  
 Waterproof.  
 Indoor use: floor, hallway, furniture protection



ABSORBENT



WATERPROOF



REUSABLE

**NOT AIRTIGHT**

**Airtight felt tarp**

DIMENSIONS	WEIGHT	SALES UNIT	REF.
10 m x 1 m	300 g/m <sup>2</sup>	Individually or pallet of 24 rolls	14 13 10

Made from a 4 mm thick non-woven synthetic material.

**ADVANTAGES**

Thick material that protects against impacts.  
 Indoor use: floors, hallway, furniture protection



ABSORBENT



SHOCK RESISTANT



HEAVY TRAFFIC



REUSABLE

FELT TARP RANGE

Absorbent top side

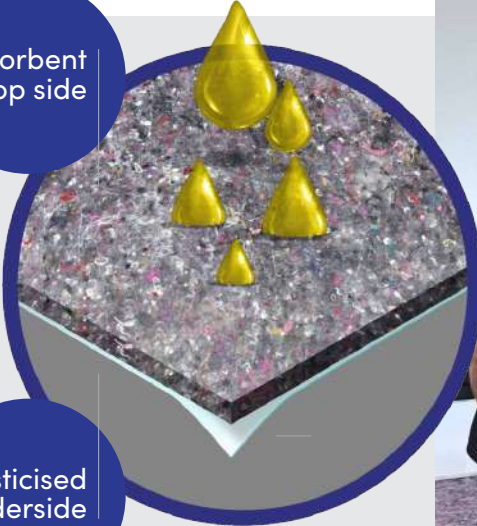

Plasticised underside



Absorbent top side

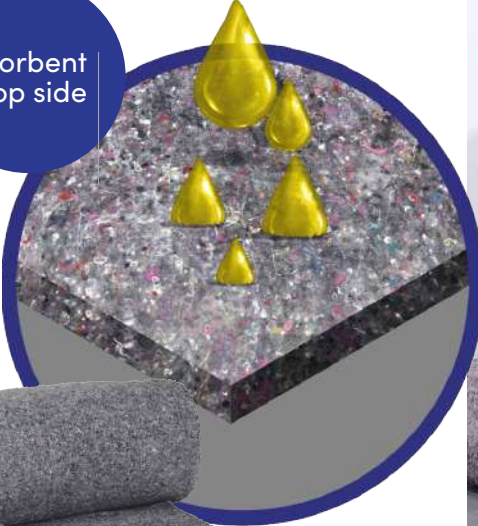

# INDOOR PROTECTION

## DulyPlak

Protective PP honeycomb panel

DIMENSIONS	SALES UNIT	REF.
Unfolded: 220 x 75 cm Folded: 76 x 75 cm	Box of 10 panels	<b>14 60 10</b>

The multi-surface, shockproof and waterproof protective panel. Made from black honeycomb polypropylene.

Thickness: 3 mm, folds/unfolds in 3 parts.

- > Excellent protection: protects against impact, heavy traffic, dust and paint spillages.
- > Suitable for high-traffic areas.
- > Modular: can be folded and easily cut to the desired size.
- > Washable and reusable.
- > Waterproof.
- > Multi-surface.



SHOCK RESISTANT



MODULAR, EASY TO CUT



HEAVY TRAFFIC

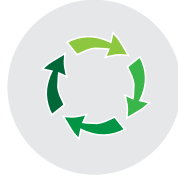

REUSABLE



INDOOR AND OUTDOOR USE

## CARDBOARD TARPS

### PROTECSOL card tarp

DIMENSIONS	SALES UNIT	REF.
25 m <sup>2</sup> ≈ 1 m x 25 m	Individually or box of 12 rolls	<b>14 50 11</b>



“Upcycled” product: product made from cardboard off-cuts, recovered and recycled

smooth, double-sided plasticised cardboard: 1 white side / 1 brown side

The product colour may vary depending on the available off-cuts (white or brown).

Weight: approximately 280 g/m<sup>2</sup>.

- > Highly resistant to scratches, tearing and puncturing.
- > Withstands heavy traffic and the use of heavy equipment (scaffolding, work platforms).
- > Waterproof and reusable



RESISTANT TO SCRATCHES AND TEARS



WATERPROOF



REUSABLE



**COTTON TARPS**



**Raw cotton tarp**

DIMENSIONS	SALES UNIT	REF.
5 m x 4 m	unit	<b>14 26 10</b>
4 m x 3 m	unit	<b>14 26 20</b>
5 m x 1.50 m	unit	<b>14 26 30</b>

PERMEABLE TARP  
 › 2 mm thick plasticised cotton.  
 › Weight: about 300 g/m<sup>2</sup>.

**ADVANTAGES**

- Highly resistant
- Reusable



**Plasticised "cotton" tarp**

DIMENSIONS	SALES UNIT	REF.
5 m x 4 m	unit	<b>14 30 10</b>
4 m x 3 m	unit	<b>14 30 20</b>
5 m x 1.50 m	unit	<b>14 30 30</b>

Plasticised fabric, composition: 65% PVC, 35% polyester  
 › 1 absorbent top side.  
 › 1 non-slip PVC underside.  
 › Weight: about 280 g/m<sup>2</sup>.

**ADVANTAGES**

- Highly resistant
- Airtight
- Reusable



**"Eco" plasticised cotton tarp**

DIMENSIONS	SALES UNIT	REF.
4 m x 3 m	Individually or box of 10 rolls	<b>14 20 10</b>
5 m x 4 m	Individually or box of 6 rolls	<b>14 20 15</b>

1 mm thick plasticised cotton.  
 › 1 absorbent top side.  
 › 1 airtight polyethylene + EVA underside of 45 microns thickness.  
 › Weight: about 200 g/m<sup>2</sup>.

**ADVANTAGES**

- Non-slip tarp
- Airtight
- Reusable



# MASKING / ADHESIVES

## Kraft masking tape

Protection against paint splashes, dirt and dust. Fully adhesive backing paper for indoor renovation jobs.

	DIMENSIONS	SALES UNIT	REF.
	75 mm x 50 m	Individually or box of 24 rolls	10 61 01
	150 mm x 50 m	Individually or box of 12 rolls	10 61 02

For use on different types of surfaces, and particularly sensitive surfaces: wallpaper, varnish, wood, etc.

### ADVANTAGES

Fully adhesive on the back  
Multi-surface protection  
Adapts to many materials

Quick and easy to apply  
Repositionable and adjustable



SELF-ADHESIVE

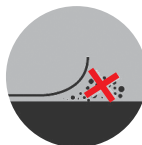

LEAVES NO MARKS



TIME-SAVING



REPOSITIONABLE



ECO-FRIENDLY  
WATER-BASED ADHESIVE  
WITHOUT SOLVENT



Hand rails, switches, electrical outlets

Radiators, windowsills

## DULYTAPÉ®

Ref. <b>10 60 61</b>	Box of 36 rolls	Dimensions: 50 mm x 25 m
----------------------	-----------------	--------------------------

Adhesive tape made from a fabric-reinforced backing in flexible polyethylene (PE), coated with a layer of special acrylic adhesive.

### ADVANTAGES

The benchmark adhesive tape for indoor applications and flat surfaces. Easy to cut.



## PP adhesive tape

Ref. <b>10 60 55</b>	Dimensions: 5 cm x 100 m
----------------------	--------------------------

Sold in packs of 6 rolls

### ADVANTAGES

Suitable for use at low temperatures.



# PACKAGING PRODUCTS

## Carpet packaging

QUALITY	DIMENSIONS	COLOUR	FOLDED IN	QTY / PALLET	NEW REF.
Pro 150	1,5 x 230 m	neutral	1	20	10 60 10



## Bubble-wrap roll

DIMENSIONS	REF.
25 x 1 m	10 75 10
100 x 1 m	10 75 15



## Stretch film for pallets

6 rolls per box

QUALITY	DIMENSIONS	REF.
Transparent 17 microns	0,45 x 270 m	10 70 10
Transparent 30 microns	0,45 x 200 m	10 70 15
Black 20 microns	0,45 x 270 m	10 70 20





## RECYCLED FABRIC



### Coloured cloths

Ref. 12 10 15

- > Coloured cloths made from knitted fabrics and t-shirts.
- > 10 kg box.
- > 100% cotton



### White cloths

Ref. 12 15 15

- > Cloths made from knitted fabrics and t-shirts.
- > 10 kg box.
- > 100% cotton



### White cloths (1 kg bag)

Ref. 12 15 10

- > Cloths made from knitted fabrics and t-shirts.
- > Box of 10 x 1 kg bags.
- > 100% cotton



### Roll of buffing wipes

Ref. 12 30 10

Dimensions: 21 x 23 cm

- > Two-ply cellulose wadding
- > 800 sheets per roll.
- > Sold in 2-roll packs.

#### ADVANTAGES

Absorbent material.



### Roll of white wipes

Ref. 12 25 10

Dimensions: 21 x 23 cm

- > Two-ply cellulose wadding
- > 800 sheets per roll.
- > Sold in 2-roll packs.

#### ADVANTAGES

Absorbent material, no colour seepage, very resistant.

## MULTI-USE, SUITABLE FOR PAINTING WORK

### Non-woven cloths

Multi-use, suitable for painting work

Ref. 12 35 35

Dimensions:  
35 cm x 50 cm

Box of 100 cloths

- > Cleaning & wiping
- > All types of surface
- > Dry or wet surface

#### ADVANTAGES

- 1 box = 1 pack of 10kg
- Resistant, thick and flexible
- Liquid absorption (water, paint)
- Does not tear, does not fall apart, lint-free
- Solvent, oil and heat resistant
- Washable and reusable

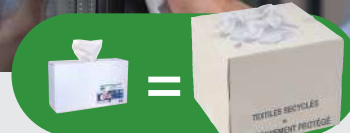

1 BOX  
100 WIPES

1 BOX  
10 KG



MADE  
IN FRANCE

# BAGS

Sorting and managing waste on construction sites is becoming a major concern.

To easily identify the contents of each bag,

Dulary now offers **transparent refuse and rubble bags**.

**Waste that is properly sorted, visible and identified in a transparent bag = an easy trip to the waste disposal centre!**

## BIN BAGS

### CHOOSING THE RIGHT BIN BAG

	LIGHT HOUSEHOLD WASTE: PAPER, CARDBOARD, PACKAGING, ETC.		HEAVY WASTE AND/OR LIQUIDS			
	BASIC PLUS	STANDARD	STANDARD	STANDARD PLUS	STANDARD PLUS	PREMIUM
THICKNESS	40 microns	45 microns	50 microns	60 microns	65 microns	80 microns
CAPACITY						
150 LITRES					11 10 35	
130 LITRES		11 08 15				
110 LITRES	11 06 10		11 06 22 11 06 20	11 06 30		11 06 40
100 LITRES		11 05 15		11 05 30		



**RECYCLED PLASTIC**



**MADE IN FRANCE**

### LDPE REFUSE BAGS

CAPACITY	QUALITY	NO. OF ROLLS PER BOX	COLOUR	NO. OF BAGS PER ROLL	REF.
100 litres	standard	10	Black	25	11 05 15
	standard plus	10	Black	20	11 05 30
110 litres	basic plus	10	Black	25	11 06 10
	standard	8	Transparent	25	11 06 22
	standard	8	Black	25	11 06 20
	standard plus	8	Black	25	11 06 30
	premium	5	Black	20	11 06 40
130 litres	standard	5	Black	20	11 08 15
150 litres	standard plus	5	Black	20	11 10 35



REINFORCED SEAM



## RUBBLE BAGS



**Transparent woven polypropylene rubble bag**

DIMENSIONS	REF.
L 56 x H 96 cm	<b>11 31 10</b>

Capacity: 60 litres - 50kg  
 Material: White woven polypropylene  
 Resealable packet of 10 bags

**ADVANTAGES**

- Highly resistant to tearing and puncturing.
- Transparent to facilitate waste sorting.
- Reusable.



**White woven polypropylene rubble bag**

Dimensions: L 56 x H 96 cm

PACKAGING	REF.
Resealable packet of 10 bags	<b>11 30 10</b>
Box of 250 bags 25 rolls of 10 bags	<b>11 30 15</b>
Bale of 1000 bags	<b>11 30 30</b>
Polypropylene bag with inner bag (sold in packs of 1000)	<b>11 30 35</b>



Capacity: 60 litres - 50kg  
 Material: White woven polypropylene

**ADVANTAGES**

- Highly resistant to tearing and puncturing. Reusable.



Jean  
 Painter and plasterer, East

After protecting the site, **clean-up is just as important...** good products to remove all the waste and rubble are essential. We trust Dulary!

# BAGS

## RUBBLE BAG

### Woven rubble bag with handles

CAPACITY	DIMENSIONS	MATERIAL	PACKAGING	REF.
60 litres 50 kg	L40 x H50 x D30 cm	White woven polypropylene	Pack of 2 bags	<b>11 35 10</b>

#### ADVANTAGES

Easy to fill and transport.  
Highly resistant to tearing and puncturing.  
Square bottom.  
Reusable.



MADE  
IN FRANCE



RECYCLED  
PLASTIC

### LDPE black rubble bag

CAPACITY	DIMENSIONS	MATERIAL	NO. OF ROLLS / BOX	NO. OF BAGS / ROLL	REF.
60 litres 50 kg	L56 x H96 cm	Polyethylene 130 microns	10	10	<b>11 20 10</b>

#### ADVANTAGES

Highly resistant to tearing.



## BIG BAG

### Big Bag Container

Ref. **11 40 10**

Dimensions: L90 x D90 x H110 cm

- › Non-laminated pp fabric, 160 g/m<sup>2</sup>, UV stabilised
- › Flat base
- › Full opening with hem
- › 4 x 30 cm straps
- › SF: 5/1

#### ADVANTAGES

Maximum resistance for a payload of 1,500 kg.



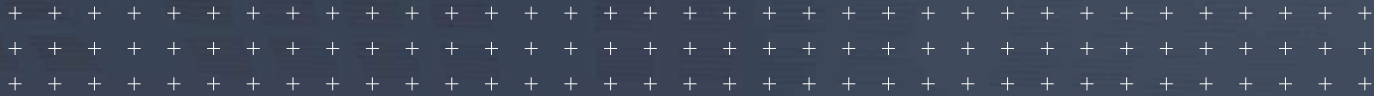

50  
ANS

EXPERTISE  
AT YOUR SERVICE  
TO PROTECT SITES  
AND PEOPLE

# PROFESSIONAL CLOTHING

Customisation and sizes ..... p. 36

**CHOOSE:**  
your clothing range ..... p. 37

Evolution Range ..... p. 38

Performance Range ..... p. 40

Expert Range ..... p. 42

Presti-comfort Range..... p. 46

Classic Range..... p. 50

Sportswear Range ..... p. 52

Cold Range..... p. 56

Complementary Range ..... p. 60

**NEW**

Women's Range..... p. 62 ♀

Rainwear Range..... p. 64



# SIZE GUIDE

## UPPER BODY

SIZES	A CHEST CIRCUMFERENCE (CM)	
	♂	♀
XS - 0	76-84	75-81
S - 1	85-92	82-87
M - 2	93-100	88-94
L - 3	101-108	95-98
XL - 4	109-116	99-103
XXL - 5	117-124	104-108
XXXL - 6	125-132	109-113

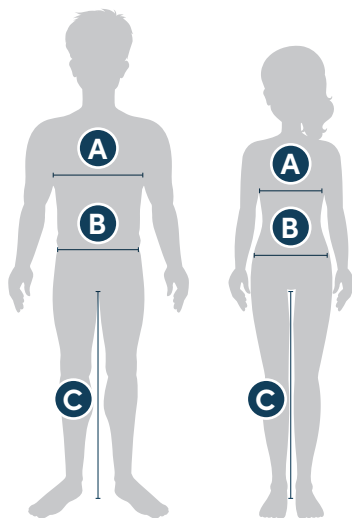

## LOWER BODY

SIZES	STANDARD SIZES	DOUBLE SIZES	B WAIST CIRCUMFERENCE (CM)		C INSIDE LEG (CM)	
			♂	♀	♂	♀
34				62		74
36	S	0	72	66	82	74
38			76	70	82	74
40	M	1	80	74	82	74
42			84	78	82	74
44	L	2	88	82	82	74
46			92	86	82	74
48	XL	3	96	92	82	74
50			100	96	82	74
52	XXL	4	104	100	82	74
54			108	104	82	74
56		5	112	108	82	74
58			116	112	82	74
60		6	120	116	82	74

## MAKE YOUR MARK ON YOUR CLOTHING

- › Clothing customisation available from 10 items upwards.
- › Available for products in the following ranges: Evolution, Classic, Complementary, Cold, Presti-Comfort, Expert, Sportswear, Woman.



Chest version 9 x 5 cm



Back version 18 x 25 cm



Please get in touch!



# CHOOSING YOUR CLOTHING RANGE:



RANGE  
**EVOLUTION**

› Technicality and design for a premium range \_\_\_\_\_ 38-39



RANGE  
**PERFORMANCE**

› Comfort, ergonomics and freedom of movement \_\_\_\_\_ 40-41



RANGE  
**EXPERT**

› Technicality and functionality for intensive use \_\_\_\_\_ 42-45



RANGE  
**PRESTI-COMFORT**

› Stylish and practical \_\_\_\_\_ 46-49



RANGE  
**CLASSIC**

› Tradition and value for money \_\_\_\_\_ 50-51



RANGE  
**SPORTSWEAR**

› Comfort and a resolutely modern style \_\_\_\_\_ 52-55



RANGE  
**COLD**

› Comfortable even outdoors \_\_\_\_\_ 56-59



RANGE  
**COMPLEMENTARY**

› To complete your outfit \_\_\_\_\_ 60-61



RANGE  
**WOMEN**



› Practical and feminine, always in style! \_\_\_\_\_ 62-63



RANGE  
**RAINWEAR**

› Dedicated protection \_\_\_\_\_ 64

DISCOVER  
OUR RANGE  
OF DISPOSABLE  
CLOTHING  
see p. 66

RANGE  
**EVOLUTION**



Technicity and design for durable, comfortable clothing that can withstand demanding working conditions, without compromising on style.



**ADVANTAGES**



**EXTREME COMFORT**



**MODERN STYLE**



**LIGHTWEIGHT**



**DURABILITY**



Stretch trousers offering unparalleled freedom of movement thanks to their ultimate stretch fabric, with Cordura reinforcements for resistance to rubbing and tears.



Elasticated fibre that stretches in all directions. For maximum comfort and freedom of movement at work.



Textile fibre 20 times more resistant to abrasion than cotton.



Triple stitching

## Lightweight sleeveless jacket

— EVOLUTION

White/black:  
ref. **48 10**

Available sizes: **from M to XXL**

**A lightweight and durable sleeveless jacket**

High neck

Zip fastening with windproof flap and concealed, covered press studs.

Elasticated armholes under flap

2 breast pockets with hidden press studs under flap + key ring

2 side pockets- 2 inside pockets

Adjustable sides using press studs

Triple stitched seams on the sides

Longer back - Retro-reflective effects

Composition:  
Twill Fabric  
65% polyester,  
35% cotton,  
270 g/m<sup>2</sup>



Reinforce-  
ments

**CORDURA**

## Stretch trousers

— EVOLUTION

White/black:  
ref. **48 01**

Available sizes: **from 36 to 54**



Evolution trousers fit small. Ask for a size larger than your usual Dulary size

**Flexibility, lightness and durability guaranteed**

Low rise

Elasticated waistband with 7 belt loops

Zip fly

Ergonomic fit

Stretch zones in prime contact areas:

- front (above the knees and bottom of the leg)
- back (top and knees)

2 Italian pockets, 2 back pockets, 1 zipped thigh pocket including a phone pocket with press stud flap, 1 Cordura® ruler pocket

Reinforced Cordura® knee pockets for inserting protective knee patches (not supplied)

Double stitched seams on legs and crotch

Composition:  
65% polyester,  
35% cotton,  
270 g/m<sup>2</sup>

**CORDURA**



Central zip

## Black fleece-lined jacket

— EVOLUTION

Black: ref. **48 20**

Available sizes: **from M to XXL**

**A flexible, slim-fit jacket**

High neck

Central zip fastening and windproof flap on the inside

Zipped breast pocket

2 zipped side pockets

Cuffs and jacket hem in elasticated bias cut

Retro-reflective effects

Composition:  
94% polyester,  
6% elastane  
Fleece  
260 g/m<sup>2</sup>

## Mascot knee pads



Ref. **49 49**

Dimensions: **150 x 270 mm**

Essential for work in a kneeling position

Pair of foam pads for knee protection compatible with the Evolution trousers

100% Ethylene vinyl acetate

RANGE

# PERFORMANCE



Our Performance range combines comfort and ergonomics with fluidity of movement.

With their fitted cut and new fabrics, these garments are now more comfortable to wear, without compromising on durability. The use of Cordura® gives these clothes optimal resistance to friction and tearing.



## ADVANTAGES



COMFORT



ERGONOMICS



FLUID MATERIAL



RESISTANCE

## CORDURA®

Textile fibre 20 times more resistant to abrasion than cotton.



DULARY ADVICE

### Adopt the Performance look:

with their lightweight fabric, Performance trousers are ideal for summer, with what you need, where you need it, so you can keep your tools close to hand.





# PERFORMANCE RANGE

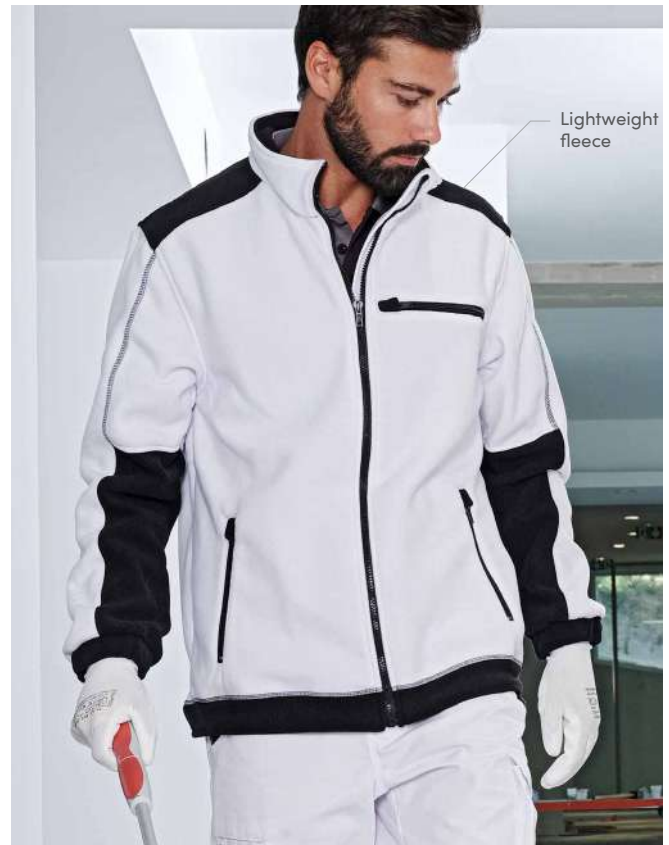

## Multi-pocket trousers

— PERFORMANCE

Grey / black: ref. **38 15**  
White / black: ref. **37 15**

Available sizes: **from 0 to 5**

Belt with 6 loops and elasticated waistband.  
1 back pocket with flap. 2 front patch pockets.  
1 front pocket with zip on the right.  
1 phone pocket on the right thigh.  
1 large bellows pocket on the left thigh.  
Nylon zip fly 1 ruler pocket + 1 tool pocket.  
Knee patches in **CORDURA** for inserting DULARY protective pads (not supplied).  
Reinforced hem.

Composition:  
60% Cotton  
40% Polyester  
250 g/m<sup>2</sup>



## Fleece jacket

— PERFORMANCE

White / black:  
ref. **37 50**

Available sizes: **from S to XXL**

Injected mesh zip up to the top of the collar.  
1 chest pocket with zip.  
2 side pockets with zip.  
Elasticated cuffs.  
2 low inside pockets

Composition:  
100% Polyester  
300 g/m<sup>2</sup>



## DULARY foam pads

Ref. **30 30**

Dimensions: 165 x 240 mm

Pair of 100% polyethylene knee protection foam pads.  
Thickness: 18 mm



TO COMPLETE YOUR KIT,  
SEE OUR RANGE OF SAFETY FOOTWEAR  
ON p.68

RANGE  
**EXPERT**



Our Expert range combines technicality and functionality.

It supports you daily, in intensive use.

The use of Cordura® gives these clothes optimal resistance to friction and tearing.



**ADVANTAGES**



**RESISTANCE AND COMFORT**



**ERGONOMICS**



**YKK ZIP**

**CORDURA®**

Textile fibre 20 times more resistant to abrasion than cotton.

**COMPLIES WITH STANDARD EN14404: 2004 + A1 : 2010**



DULARY is committed to combating disorders linked to the kneeling position (bursitis of the knee) with the standard EN14404: 2004 + A1: 2010.

This standard guarantees users that they are wearing equipment that will protect them and prove entirely suitable to working in a kneeling position. The standard involves the wearing of Expert trousers exclusively fitted with DULARY foam pads.

GREY / BLACK



YKK zip

Double holster pockets with lining in

**CORDURA**

BEIGE / BLACK



Reinforced knee patches

**CORDURA**

Reinforced trouser hem

**CORDURA**

WHITE / BLACK



## Multi-pocket trousers

--- **EXPERT**

Grey / black:ref. **33 15**  
Beige / black:ref. **32 15**  
White / black:ref. **30 15**

Available sizes: **from 36 to 54**

Belt with 7 loops and elasticated waistband and 1 key ring. 2 back pockets with rip-tab flap, 2 front patch pockets that can hold 2 double holster pockets, nylon fly, 1 ruler pocket, 1 side tool pocket, 2 bellows pockets and 1 phone pocket. Knee patches in **CORDURA** for inserting DULARY protective pads (not supplied). Triple stitched seams at the crotch.

Composition (white, grey):  
60% Cotton  
40% Polyester  
310 g/m<sup>2</sup>

Composition (beige):  
65% Polyester  
35% Cotton  
310 g/m<sup>2</sup>

**CORDURA**



**Available in women's fit**

See page 63



## DULARY foam pads

Ref. **30 30**

Dimensions: 165 x 240 mm

Pair of foam pads for knee protection compatible with DULARY trousers. 100% polyethylene. Thickness: 18 mm



EN14404: 2004 + At: 2010



### Expert stretch jeans

--- EXPERT

Ref. **34 15**

Available sizes: **from 36 to 54**

The modern working jean with stretch for maximum comfort

- Belt with 5 loops.
- 2 back pockets,
- 2 front Italian pockets.
- YKK zip fly,
- 1 key ring,
- 1 ruler pocket,
- 1 tool pocket,
- 1 zipped bellows pocket,
- 2 small rip-tab flap pockets.
- Reinforced polyester knees

**Composition:**  
89% cotton,  
9% elastic  
polyester,  
2% elastane,  
+/- 320 g/m<sup>2</sup>

Adjustable,  
Elasticated.



### Elastane belt

Ref. **30 32**

Dimensions: 120 x 4 cm

Outer material: 50% polypropylene, 50% elastane.  
Metal buckle. Waist size adjustment for trousers and shorts  
Colour: black

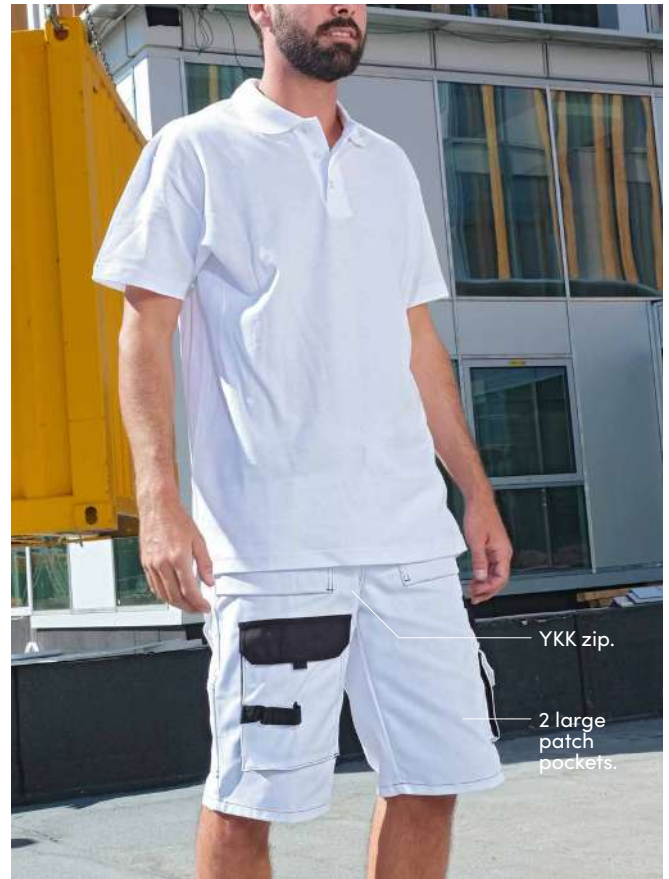

### Shorts

--- EXPERT

White: ref. **30 35**

Available sizes: **from 36 to 54**

- 7 belt loops with elasticated waistband and key ring,
- 2 back pockets with rip-tab flap,
- 2 front patch pockets, nylon YKK fly.
- 1 ruler pocket, 1 tool pocket on the side,
- 2 bellows pockets and 1 phone pocket.

**Composition:**  
60% Cotton  
40% Polyester  
310 g/m<sup>2</sup>



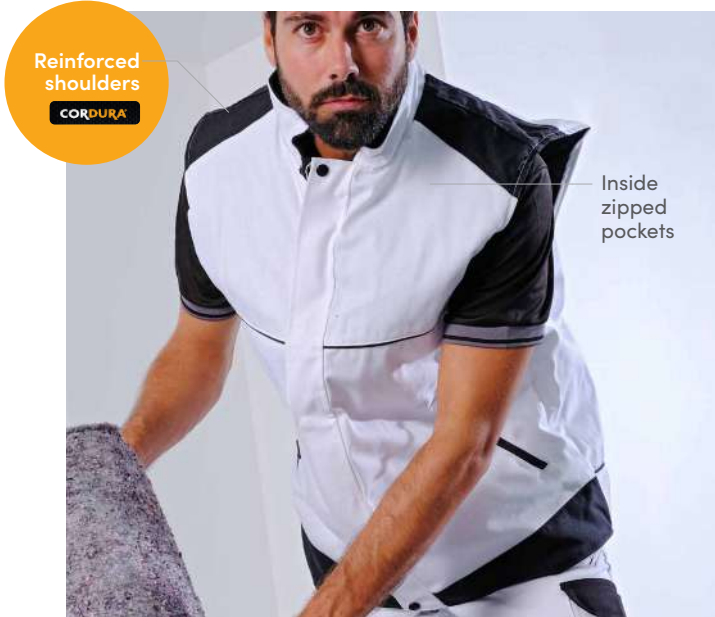

### Cotton/polyester sleeveless jacket

— **EXPERT** —

White/black:  
ref. **30 71**

Available sizes: **from M to XXL**

Black micro-fleece inside collar  
Reinforced shoulders + hem in **CORDURA**  
2 bias-cut zip pockets  
1 inside wallet zip pocket  
1 inside smartphone pocket with rip-tab flap  
1 lower inside zip pocket  
Two-way zip under flap with press studs.

Composition:  
60% Cotton  
40% Polyester  
Padded lining  
100% polyester  
280 g/m<sup>2</sup>  
**CORDURA**



### Cotton/polyester jacket

— **EXPERT** —

White/black:ref.  
**30 76**

Available sizes: **from M to XXL**

Black micro-fleece lining.  
Black micro-fleece inner standing collar.  
1 pen pocket on left sleeve.  
2 bias-cut pockets with zip.  
1 inside wallet pocket.  
1 inside smartphone pocket with velcro flap.  
1 lower inside zip pocket. Two-way zip under flap with press studs.

Composition:  
60% Cotton  
40% Polyester  
**CORDURA**



### Polo shirt

— **EXPERT** —

Black/grey: ref. **30 60**

Available sizes: **from S to XXL**

Quick drying to help wick away perspiration, classic collar, 3 buttons, velour neck band. Collar and sleeves with contrasting edging.

Composition:  
100% Polyester  
140 g/m<sup>2</sup>





RANGE  
**PRESTI-COMFORT**

The Presti-Comfort range combines style and practicality.

Suitable for summer and winter alike, comfortable and coordinated clothing with a quality finish.



**ADVANTAGES**



**QUALITY MANUFACTURING**



**PROTECTIVE KNEE PATCHES**



**RESISTANT ZIP**

# PRESTI-COMFORT RANGE



Knee patch reinforcement with ergonomic gusset



Functional with multiple pockets.

Perfect for summer: lighter fabric 245 g/m<sup>2</sup>

## Trousers

— PRESTI-COMFORT

White/grey:  
ref. **28 11**

Available sizes: **from T0 (36/38) to T5 (56/58)**

Stock halved:  
6 double sizes  
= 12 sizes!

2 two-colour bias-cut patch pockets.  
2 back pockets, one with a Velcro® flap.  
1 ruler pocket + 1 tool pocket on the right side.  
1 Velcro® pocket on the side. YKK nylon zip fly.  
5 belt loops. Knee reinforcements with compartments for protective pads (not supplied). Ergonomic gusset on the knees and height-adjustable foam pads.

Composition:  
60% Cotton  
40% Polyester  
310 g/m<sup>2</sup>

## Multi-pocket trousers

— PRESTI-COMFORT

White/grey:  
ref. **28 15**

Available sizes: **from 36 to 54**

2 back pockets with rip-tab flap,  
1 large bellows pocket with rip-tab flap on each side, nylon fly,  
7 belt loops, elasticated waistband,  
2 two-colour bias-cut patch pockets,  
1 key ring, right side: 1 tool pocket + 1 phone pocket + 1 pen pocket.  
YKK zip.  
Height adjustable.

Composition:  
65% Polyester  
35% Cotton  
245 g/m<sup>2</sup>



DULARY ADVICE

**Customise your clothing!**

See our range  
p. 36



## Dulary foam pads

Ref. **30 30**

Dimensions: 165 x 240 mm

Pair of 100% polyethylene knee protection foam pads.  
Thickness: 18 mm



50  
ANS

Cyril  
Painter, Ile-de-France

I'm a fan of the Presti-Comfort trousers; but not just them, I've even added the gilet to the set!

**I like the practicality: the comfortable cut, there are pockets...**

**In short, a well-thought-out range!**





# PRESTI-COMFORT RANGE



## Jacket

PRESTI-COMFORT

White/grey: ref. **28 75**

Available sizes: **from M to XXL**

Black micro-fleece lined collar, 1 outer pocket, 2 lower zipped pockets, elasticated cuffs, adjustable rip-tab waistband, 1 inside wallet pocket with zip, 1 phone pocket with rip-tab flap (for Smartphone).

**Composition:**  
65% Polyester  
35% Cotton  
310 g/m<sup>2</sup>  
Lining  
100% polyester  
250 g/m<sup>2</sup>



## Fleece-lined sleeveless jacket

PRESTI-COMFORT

White/grey:  
ref. **28 70**

Available sizes: **from M to XXL**

Grey collar. White fleece lining. 1 large breast pocket + 1 phone pocket. 1 inside pocket. 4 large lower pockets, 2 of which have flaps. Nylon zip + press studs.

**Composition:**  
65% Polyester  
35% Cotton  
240 g/m<sup>2</sup>  
Lining  
100% Polyester  
250 g/m<sup>2</sup>



## Shorts

PRESTI-COMFORT

White / grey:  
ref. **28 35**

Available sizes: **from 36 to 58**

2 two-colour bias-cut patch pockets, 2 back pockets with rip-tab flap, 1 ruler pocket / 1 tool pocket on the side / 1 side rip-tab pocket. Nylon YKK fly, 5 belt loops.

**Composition:**  
60% Cotton  
40% Polyester  
310 g/m<sup>2</sup>



## Polo shirt

PRESTI-COMFORT

White/grey: ref. **28 60**

Available sizes: **from S to XXL**

Quick drying to help wick away perspiration. Collar and sleeves with contrasting edging. Classic collar. 3 buttons. Velour neck band.

**Composition:**  
100% Polyester  
140 g/m<sup>2</sup>



RANGE  
**CLASSIC**

Simple and discreet tradition: the hallmark of our Classic range.



ADVANTAGES



QUALITY  
MANUFACTURING



ERGONOMICS  
FOR COMFORT



**Overalls**

CLASSIC

White:  
ref. **22 55**

Available sizes:  
from 0 to 6

2 zipped chest pockets,  
2 bias-cut patch pockets,  
1 back pocket + 1 ruler  
pocket, double zip,  
elasticated waistband  
+ back gussets,  
buttoned cuffs.

Composition:  
100% Cotton  
320 g/m<sup>2</sup>



**Bib and brace overalls**

CLASSIC

White:  
ref. **22 45**

Available sizes:  
from 0 to 6

2 bias-cut side pockets,  
1 back pocket + 1 ruler  
pocket, 1 large bib pocket  
with zip + pen holder,  
adjustable elasticated  
straps.

Composition:  
100% Cotton  
320 g/m<sup>2</sup>



**Straight coat**

CLASSIC

White:  
ref. **22 56**

Available sizes:  
from 0 to 6

2 patch pockets,  
1 chest pocket,  
1 inside pocket,  
tailored collar,  
buttoned cuffs.

Composition:  
100% Cotton  
320 g/m<sup>2</sup>



## Jacket

CLASSIC

White: ref. **22 50**

Available sizes: **from 0 to 6**

3 patch pockets, 1 inside pocket, tailored collar, buttoned cuffs.

Composition:  
100% Cotton  
320 g/m<sup>2</sup>



Jeans with rivets

## Jeans

CLASSIC

White: ref. **24 25**

Available sizes: **from 36 to 60**

5 belt loops  
Button fly  
2 bias-cut patch pockets.  
1 small front pocket with rivets  
1 ruler pocket  
2 back pockets

Composition:  
60% Cotton  
40% Polyester  
300 g/m<sup>2</sup>



## Trousers

CLASSIC

Available sizes: **from 36 to 60 except: ref. 2610 up to 54**

2 bias-cut patch pockets,  
1 back pocket,  
1 ruler pocket,  
belt loops, button fly.

**For added comfort, our trouser range comes in 3 types of fabric:**

White: ref. **22 10**

- › Comfortable, absorbs perspiration.
- › Resists welding sparks.
- › Washable at high temperature.

Composition:  
100% Cotton  
320 g/m<sup>2</sup>

White: ref. **24 10**

- › Reinforced cotton.
- › Comfortable, absorbs perspiration.
- › Washable at high temperature.
- › Easy care, resistant to tearing, garment lifespan of more than 50 washes.

Composition:  
60% Cotton  
40% Polyester  
300 g/m<sup>2</sup>

White: ref. **26 10**

- › Polyester/Cotton.
- › Entry price.

Composition:  
65% Polyester  
35% Cotton  
250 g/m<sup>2</sup>



RANGE  
**SPORTSWEAR**

When work clothing gets a sportswear look!  
Comfortable, ergonomic clothing that offers great freedom of movement.



ADVANTAGES



COMFORTABLE FLEECE



PROTECTIVE KNEE PATCHES



ERGONOMICS



FIT CUT





### Mouv hooded sweatshirt

— SPORTSWEAR

White ref **47 20**  
 Navy ref **47 21**

Available sizes: from **S** to **XXL**

**A comfortable fleece work sweatshirt for a stylish look**

- Hood with drawcord
- Hood lining in contrasting jersey
- Raglan sleeves
- Reinforced ribbing on body and cuffs

Composition:  
 Fleece  
 65% Cotton  
 35% Polyester  
 300 g/m<sup>2</sup>



### Mouv work joggers

— SPORTSWEAR

White ref **47 30**  
 Navy ref **47 31**

Available sizes: from **S** to **XXL**

**A fleece work sweatshirt for maximum comfort**

- Elasticated drawcord waistband
- 2 slant pockets
- 1 mesh pocket with flap
- 1 reinforced ruler pocket
- Fitted cut with elastic cuffs
- Knee reinforcements with compartments for protective pads (not supplied)

Composition:  
 Fleece  
 65% Cotton  
 35% Polyester  
 300 g/m<sup>2</sup>



### Craft black Ripstop sleeveless jacket

— SPORTSWEAR

Black: ref. **47 01**

Available sizes: from **S** to **XXL**

**A light and durable sleeveless jacket**

- Anti-cold zip fastening
- 2 zipped bias-cut pockets
- 1 inside pocket
- Bias cut cuffs

Composition:  
 PU-coated  
 Ripstop polyamide fabric  
 Polyester  
 taffeta  
 lining

# SPORTSWEAR RANGE



50  
ANS

Matthieu  
Painter, South East

In tune with the times!

**Be comfortable  
while you work!**

That's what I like about the Dulary Sportswear range. I've discovered jogging, and since then I've worn the shorts for the summer.





## Mouv sleeveless jacket

--- SPORTSWEAR

White: ref. **47 50**

Available sizes:  
from **S** to **XXL**

a soft and lightweight zipped gilet  
2 zipped low pockets,  
1 Napoleon chest pocket,  
Lower body reinforced rib edging 450 g/m<sup>2</sup>

Composition:  
Non-brushed  
fleece  
65% cotton  
35% polyester  
280 g/m<sup>2</sup>



## Mouv shorts

--- SPORTSWEAR

White:ref. **47 40**  
Navy:ref. **47 41**

Available sizes:  
from **S** to **XXL**

Lightweight and comfortable work shorts  
Adjustable elasticated drawcord waistband  
2 Italian pockets  
1 mesh pocket with rip-tab flap  
on the left leg, 1 reinforced fabric  
ruler pocket on the right leg

Composition:  
Non-brushed  
fleece  
65% cotton  
35% polyester  
280 g/m<sup>2</sup>

# RANGE COLD



The Cold range perfectly complements our range of work clothing.

Style and comfort for the outdoors, or in the coldest seasons!







**50**  
ANS

**NEW**  
**2024**

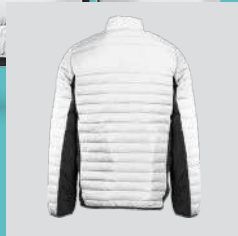

## Allure white padded jacket

--- COLD

White/black: ref. **4031 men**  
ref. **4032 women**

Available sizes:  
from **S** to **XXL**

Modern, lightweight, two-material padded jacket in a slim fit.

2 zipped side pockets.

2 inside pockets.

Chin protection.

Contrasting zips.

Composition:  
100% polyester,  
180 g/m<sup>2</sup>

### ADVANTAGES

Comfortable  
Modern cut



**Specially adapted women's fit**





### Area sleeveless jacket

— COLD

White: ref. **40 18**

Available sizes: **from S to XXL**

The stretch sleeveless jacket.  
 High collar  
 Central zip  
 Elasticated bias-cut cuffs and hem  
 2 vertical low pockets with zip flap,  
 2 inside patch pockets with rip-tab fastening  
 5,000 mm waterproofing  
 400 g/m<sup>2</sup>/24hr breathability

**Composition:**  
**External:**  
 100% mechanical stretch polyester + TPU 100 g/m<sup>2</sup> membrane  
**Main lining:** 100% polyester 220 g/m<sup>2</sup>  
**Lining 2:** 100% polyester taffeta lining



### Urban sleeveless jacket

— COLD

Blue: ref. **40 16**

Available sizes: **from S to XXL**

**A practical and functional lightweight sleeveless jacket**

Retro-reflective central zip  
 High collar, chin guard, elasticated bias-cut cuffs and waist  
 2 inside patch pockets with rip-tab fastening

**Composition:**  
 Exterior: 100% polyester 65 g/m<sup>2</sup>  
 Main lining: Quilted 100% polyester 160 g/m<sup>2</sup>  
 Second lining: taffeta lining 100% polyester 60 g/m<sup>2</sup>



### Ripstop Challenge Jacket

— COLD

Blue/orange: ref. **40 24**

Available sizes: **S - XXL**

**A dual-material ripstop jacket for better durability**

Fixed hood - Anti-cold zip fastening  
 Ribbed cuffs  
 2 breast pockets 2 side pockets  
 1 inside zipped pocket  
 Reflective piping on front and back  
 Badge holder included

**Composition:**  
 Quilted ripstop polyamide fabric with PU coating  
 Inserts: Laminated 2-layer polyester fabric  
 Polyester taffeta lining

Stylish  
 Lightweight  
 2 side pockets



### Black city sleeveless jacket

— COLD

Black: ref. **40 15**

Available sizes: **from M to XXL**

**A stylish urban sleeveless jacket. Water-repellent and windproof. Waistband drawcord.**

**Composition:**  
 100% polyester pongee exterior  
 100% Polyester taffeta padded interior



## Rocket Softshell Jacket

— COLD

Black/orange:  
ref. **40 37**

Available sizes: **from S to XXL**

**A lightweight jacket that's ideal for outdoor use**

3 layer softshell

Anti-cold zip fastening

Fixed hood

2 breast pockets 2 side pockets

Reflective piping on front and back

Removable badge holder included

**Composition:**  
Softshell fabric  
96% polyester  
4% elastane  
3 laminated layers



RIPSTOP  
anti-  
abrasion

## Heather Grey Fleece Street Jacket

— COLD

Heather grey:  
ref. **40 19**

Available sizes: **S - XXL**

**Warm and comfortable jacket**

High collar

Central zip

1 ripstop patch pocket with zip

2 vertical lower pockets

2 lower bottom pockets

Ribbed cuffs and hem

Anti-abrasion

Ripstop inserts on the elbows

**Composition:**  
Fleece: 80% cotton,  
20 % polyester  
Ribbing: 100%  
Polyester  
Ripstop (5mm): 100%  
PVC coated polyester.  
300 g/m<sup>2</sup>



## Black fleece jacket

— COLD

Black:  
ref. **40 25**

Available sizes:  
**from S to XXL**

Nylon zip.

Set-in sleeves

with elasticated cuffs.

Elasticated drawstring  
at the bottom.

2 lower zip pockets.

**Composition:**  
100% Polyester  
340 g/m<sup>2</sup>



## Fleece snood

— COLD

Black:  
ref. **40 53**

Size: **one size**

**An accessory suited to all cold environments.**

Light and comfortable

Multifunctional

Versatile

**Composition:**  
100% fleece.  
300 g/m<sup>2</sup>  
Drawstring



## Black fleece hat

— COLD

Black:  
ref. **40 50**

Size: **one size**

Fleece hat (280 g/m<sup>2</sup>)



PROFESSIONAL CLOTHING

RANGE

# COMPLEMENTARY

Items delivered in individual packaging

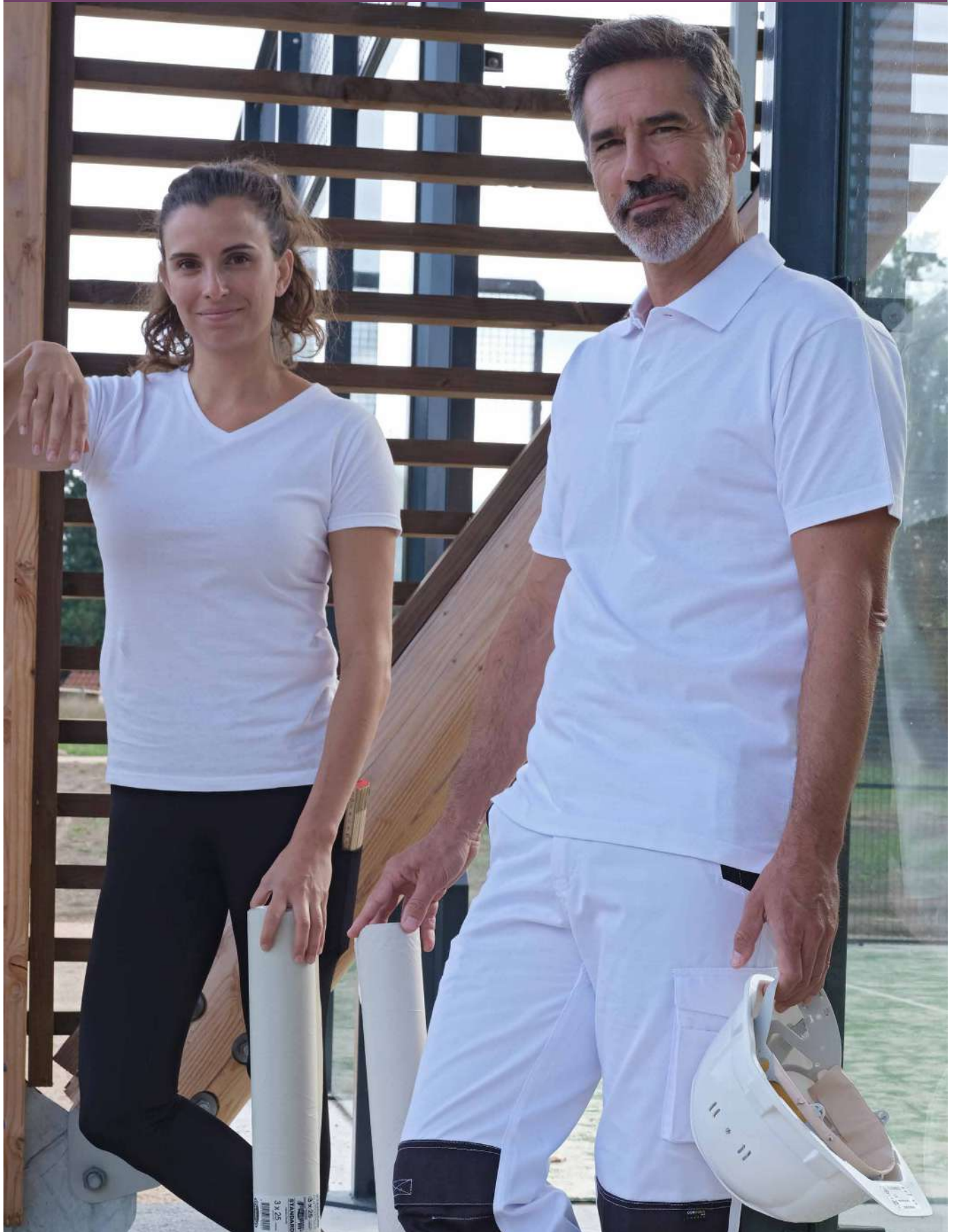

PROFESSIONAL CLOTHING  
**COMPLEMENTARY** RANGE

OEKO-TEX®  
CONFIDENCE IN TEXTILES  
**STANDARD 100**



OEKO-TEX®  
CONFIDENCE IN TEXTILES  
**STANDARD 100**



Ribbed edging  
 on neck,  
 cuffs and hem.



Available in  
 women's fit,  
 V-neck  
 See p.63

### T-shirt

COMPLEMENTARY

White: ref. **42 10** | Sizes:  
 from M to XXL

Double stitched crew neck. **Composition:**  
 100% Combed  
 cotton  
 145 g/m<sup>2</sup>

### Crew neck long-sleeved t-shirt

COMPLEMENTARY

White: ref. **42 13** | Sizes:  
 from M to XXL

Crew neck. Double stitched  
 neck, cuffs and hem  
 on the garment. **Composition:**  
 100% Combed  
 cotton  
 160 g/m<sup>2</sup>

### White sweatshirt

COMPLEMENTARY

White: ref. **42 25** | Sizes:  
 from M to XXL

Back collar panel.  
 Straight sleeves.  
 Double stitched neck,  
 shoulders, sleeves  
 and waist. **Composition:**  
 80% Combed  
 cotton  
 20% Polyester  
 300 g/m<sup>2</sup>



WHITE

GREY

### Polo shirt

COMPLEMENTARY

White: ref. **42 20** | Sizes: from M to XXL  
 Grey: ref. **42 21**

Piqué knit. Standard collar. 3 buttons. **Composition (grey):**  
 85% Cotton  
 15% Viscose  
 220 g/m<sup>2</sup> **Composition (white):**  
 100% Cotton  
 Piqué knit  
 190 g/m<sup>2</sup>



Zipped collar,  
 modern fit

GREY

WHITE

### Zip-neck sweatshirt

COMPLEMENTARY

White: ref. **42 30** | Sizes: from M to XXL  
 Grey: ref. **42 35**

High collar, sleeves and inner edges  
 ribbed with elastane. Covered placket  
 with matching zip. **Composition:**  
 80% Cotton  
 20% Polyester  
 280 g/m<sup>2</sup>

RANGE  
**WOMEN** ♀

50  
ANS

**NEW**  
2024



**Allure white padded jacket**

--- COLD

White/black:  
ref. **4032 women**

Available sizes:  
from **S to XXL**

Modern, lightweight,  
two-material padded jacket  
in a slim fit.

Composition:  
100% polyester,  
180 g/m<sup>2</sup>

- 2 zipped side pockets.
- 2 inside pockets.
- Chin protection.
- Contrasting zips.

**ADVANTAGES**

- Comfortable
- Modern cut.





## Women's leggings

WOMEN

White: ref. **42 55** | Available sizes:  
S/M - L/XL - (XXL/XXXL on request)

Long leggings with pocket  
High waist with good waistband support.  
Wide elasticated waistband.  
Phone pocket in the seam

Composition:  
86% polyester  
14% elastane.  
260 g

### ADVANTAGES

Comfort - freedom of movement



## Women's t-shirt

WOMEN

White: ref. **42 11** | Available sizes:  
from S to XXL

Short-sleeved t-shirt, V-neck,  
contemporary look

Composition:  
100% cotton,  
150 g/m<sup>2</sup>

### ADVANTAGES

Lightweight  
The basic essential



SEE  
OUR FULL  
RANGE  
OF SAFETY  
FOOTWEAR  
see p. 69

## Alice S3 Trainer

WOMEN

Ref. **62 30** | Sizes: from 35 to 41

**Low-top trainer for both comfort and femininity**

- › Upper: water-repellent nubuck
- › Lining: 100% polyester, breathable, antibacterial, absorbent, anti-abrasion
- › Sole: anti-perforation PU, non-slip (SRC)
- › Toe cap: aluminium

**Weight: 557g - Standardised S1P SRC shoe**

### ADVANTAGES

Flexible and comfortable  
Transparent  
non-marking outsole.



Reinforced  
knee patches

CORDURA

## Women's Expert trousers

WOMEN

White/black: ref. **30 20** | Available sizes:  
from 34 to 48

Belt with 7 loops and elasticated waistband.  
2 piped back pockets, 2 slanted front pockets,  
nylon fly, 1 ruler pocket, 1 tool pocket  
on the side, 2 bellows pockets  
and 1 phone pocket.

Knee patches **CORDURA** with compartments for  
DULARY protective foam pads (not included).

Composition:  
60% Cotton  
40% Polyester  
310 g/m<sup>2</sup>

RANGE  
**RAINWEAR**



**Entry price outfit**

— RAINWEAR

Yellow: ref. **46 10**

Sizes: **from L to XXL**

Double PVC-coated cotton/polyester lining.

Waterproof, sewn and bonded.

Drawcords: hood, windproof sleeves and waist.

Back ventilation.

2 trouser pockets/2 side pockets with flap.



**Flexible outfit**

— RAINWEAR

Green: ref. **46 26**

Sizes: **from L to XXL**

Flexible PVC-coated polyester 200 g/m<sup>2</sup>.  
Waterproof.

Airtight seams, integrated hood, zipped collar. Adjustment/tightening at openings.

Back ventilation. Elasticated waistband.

Hand slits

Adjustable legs using press studs.

2 jacket pockets.



**Green overalls**

— RAINWEAR

Green: ref. **46 30**

Sizes: **from M/L to XL/XXL**

Polyester coated PVC on the inside and outside.

Double zip from collar to feet.

Removable hood.

2 chest pockets and 2 side pockets.

**DISCOVER  
OUR RANGE  
OF DISPOSABLE  
CLOTHING**  
see p. 66







50  
ANS

EXPERTISE  
AT YOUR SERVICE  
TO PROTECT SITES  
AND PEOPLE

# 03 PERSONAL PROTECTION

Disposable clothing ..... p. 66

Socks ..... p. 67

**CHOOSE:**  
your safety footwear ..... p. 67

Safety footwear ..... p. 68

**CHOOSE:**  
your gloves ..... p. 73

Hand protection ..... p. 74

**CHOOSE:**  
your single-use mask ..... p. 76

Breathing protection ..... p. 77

Eye protection ..... p. 82

Head protection ..... p. 84

Safety products ..... p. 85



# DISPOSABLE CLOTHING

## MAKE THE RIGHT CHOICE

Overalls	Level of protection	Risk	Use
Polypro	Category 1	Minor	Protection against minor risks, dirty work in non-hazardous environments.
Weepro	Category 3 Types 5 and 6	Serious or irreversible	Protection against irreversible risks, disinfection.
Tyvek® Ventilated back			



### Polypro Overall

DISPOSABLE

Ref. 44 10

Sizes: XL and XXL

Sold in packs of 10 per size.

Disposable overalls in non-woven polypropylene (40 g/m<sup>2</sup>). Zip fastening. Elasticated cuffs, waistband, ankles and hood.



### Polypro overall

DISPOSABLE

Ref. 44 20

Sizes: from M to XXL

Sold in packs of 10 per size.

Microporous non-woven film (60 g/m<sup>2</sup>) disposable overalls. Hooded design. Zip with self-adhesive close flap. Elasticated cuffs, hood and ankles.



### TYVEK® COVERALL

DISPOSABLE

Ref. 44 30

Sizes: from M to XXL

Sold in packs of 25 per size.

100% polypropylene non-woven Tyvek® disposable overalls (41 g/m<sup>2</sup>). Hooded design. Zip with close flap. Elasticated hood, cuffs, waist and ankles.



### Ventilated back overalls

DISPOSABLE

Ref. 44 25

Sizes: from M to XXL

Sold in packs of 25 per size.

Microporous film (65 g/m<sup>2</sup>) disposable overalls. Ventilated back in blue SMS (55 g/m<sup>2</sup>). Zip with adhesive close flap. Elasticated hood, cuffs, waist and ankles.



### Disposable polypropylene overboots

DISPOSABLE

Ref. 44 40

Size: one size

Sold by the pair

100% polypropylene non-woven overboots. Single-use for protecting floors in controlled areas. Height: 49 cm. 2 holding ties.



SOCKS



Sizes:  
XS (36-38) - S (39-41)  
M (42-44) - L (45-47)

THE HEAVY-DUTY WINTER SOCK TO KEEP YOUR FEET WARM AND DRY.

- › High quality winter sock, made of SANITIZED® anti-bacterial and anti-odour treated cotton and COOLMAX yarn
- › Entirely made of terry cloth to ensure good thermal insulation
- › Elasticated band designed for better adherence to the foot and to prevent blistering.
- › Reinforced toe and heel



Ref. **60 01**  
Composition:  
60% cotton  
27% COOLMAX® polyester  
8% nylon  
5% LYCRA® elastane

THE SUMMER SOCK THAT LETS YOUR FEET BREATHE IN OPTIMAL COMFORT.

- › High quality summer sock made entirely of nylon-reinforced mercerised cotton
- › Zone with anti-perspiration mesh on the back to increase breathability
- › Optimal adherence to the foot thanks to an elasticated strip that prevents blistering



Ref. **60 02**  
Composition:  
78% mercerised cotton  
17% nylon  
3% LYCRA® elastane  
2% cotton

THE PRACTICAL, COMFORTABLE AND BREATHABLE SHORT SUMMER SOCK



Ref. **60 03**  
Composition:  
78% mercerised cotton  
17% nylon  
3% LYCRA® elastane  
2% cotton

CHOOSING YOUR SAFETY FOOTWEAR



Good safety footwear should be light, flexible and resistant - not to mention stylish!

4 ranges to cater to your needs:

TECHNICAL RANGE

SPORT RANGE

CASUAL RANGE

THE ESSENTIALS

SAFETY FOOTWEAR AS PER THE EN ISO 20345:2011 STANDARD

Standard valid until 2027

SLIP RESISTANCE STANDARD:

SRA = ceramic surface + detergent solution  
SRB = steel surface + glycerine  
SRC = SRA + SRB

	SB	S1	S1P	S2	S3
Non-slip properties (SRA/SRB/SRC)	✓	✓	✓	✓	✓
Protective toe cap	✓	✓	✓	✓	✓
Perforation resistance (P)			✓		✓
Closed heel zone	open heel possible	✓	✓	✓	✓
Hydrocarbon resistance of the sole (FO)		✓	✓	✓	✓
Antistatic properties (A)		✓	✓	✓	✓
Shock absorbing heel (J)		✓	✓	✓	✓
Waterproof (WRU)				✓	✓
Contoured sole					✓
Suitable for use		in dry conditions		in wet conditions	

ADDITIONAL STANDARDS:

HRO = outsole resistance to heat contact (60 secs to 300°)  
ESD = shoes with electrostatic overload dissipation  
CI = shoe insulation against the cold (30 mins to -20°)  
HI = shoe insulation against the heat (30 mins to 150°)



## TECHNICAL RANGE



**Greenfit Reconverted Trainer S1P unisex** 

Ref. **66 00** | Sizes: from 35 to 47

**Eco-friendly low-top shoe**

- › Upper: 100% PET ecological fabric
- › Lining: 100% polyester, breathable, antibacterial, anti-abrasion
- › Sole: Made of virgin and recycled PU. Anti-perforation, non-slip (SRC), anatomical, antistatic, flexible and comfortable
- › Toe cap: aluminium + anti-abrasion leather covering

**Weight: 592g - Standardised S1P SRC shoe**

**ADVANTAGES**

Eco-friendly: made from 9 PET bottles  
 Anti-abrasion leather toecap cover  
 Grey non-marking outsole.



## Puma Trainer Frontside S1P

Ref. **66 31** | Sizes: from 38 to 46

### Low-top sporty shoe

- › Upper: microfibre, highly resistant nylon fabric, highly breathable Sandwich-Mesh
- › Lining: BreathActive Multifunction lining
- › Sole: Anti-perforation, thermal insulation, super non-slip, flexible FAP® lite
- › Toe cap: fibreglass

**Weight: 520 g - Standardised S1 SRC shoe**

### ADVANTAGES

Unparalleled comfort: maximum energy recovery and cushioning with its EFFECT.FOAM® sole  
 The quality and expertise of a recognised brand.  
 Metal-free



## Mugello S1P Trainer

Ref. **66 10** | Sizes: from 38 to 47

### Black low-top Safety-Tex shoe

- › Upper: Safety-Tex
- › Lining: 100% honeycomb polyamide
- › Sole: high density for greater resistance to wear, abrasion and oil; non-slip, anti-static and anti-perforation. Insole: breathable
- › Toe cap: composite

**Weight 466g - Standardised shoe: S1P SRC**

### ADVANTAGES

Technicality, comfort.



## Assen S3 Trainer

Ref. **66 11** | Sizes: from 38 to 47

### High-top shoe in black oiled full grain leather

- › Upper: Safety-Tex
- › Lining: 100% honeycomb polyamide
- › Sole: high density for greater resistance to wear, abrasion and oil; non-slip, anti-static and anti-perforation. Insole: breathable
- › Toe cap: composite

**Weight 526 kg - Standardised shoe: S3 SRC**

### ADVANTAGES

Technicality, comfort, good ankle support.



SPORT RANGE



### Impulse Lift S1P Trainer

Ref. 65 50

Sizes: from 38 to 47

Lightweight trainer for incomparable comfort

- › Upper: Seamless durable Mesh fabric
- › Lining: breathable
- › Sole: refined non-slip, anti-perforation and heat-resistant rubber
- › Toe cap: fibreglass

Weight: 533g - Standardised S1P ESD HRO SRA shoe

#### ADVANTAGES

Maximum shock absorption, excellent stability, long-lasting comfort thanks to Anti-Fatigue technology: ImpulseFoam® midsole and comfitAir® insole.

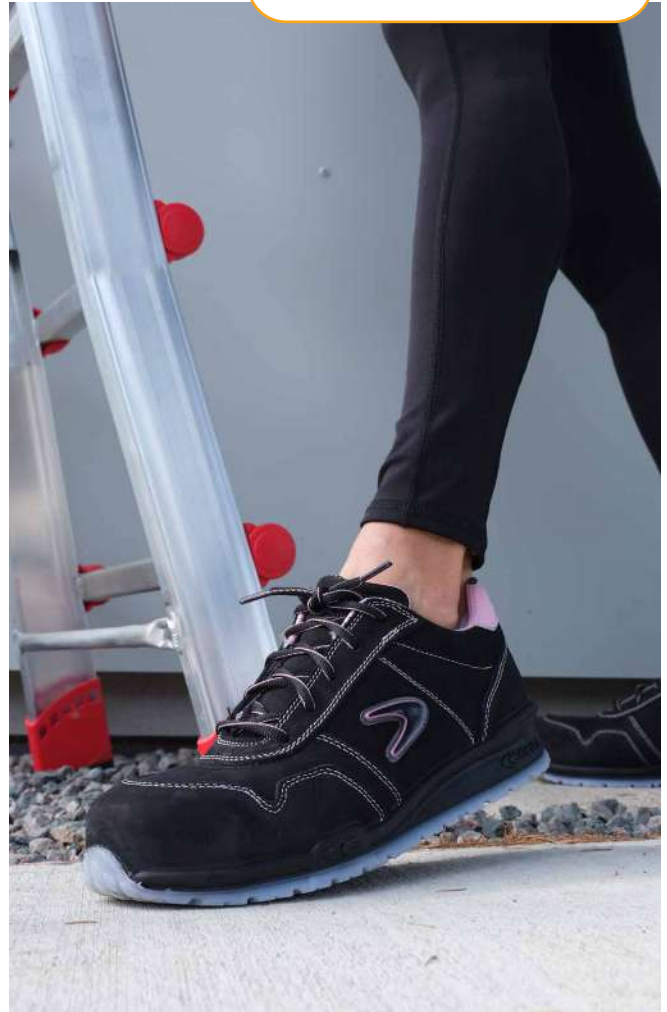

### Hallo black/orange S1P Trainer

Ref. 61 00

Sizes: from 37 to 47

Light and breathable low-top trainer

- › Upper: 100% fly-knit polyester
- › Sole: anti-perforation and non-slip (SRA) PU, oil resistant
- › Toe cap: metal

Weight: 473g - Standardised S1P SRA shoe

#### ADVANTAGES

Lightweight trainer  
Combining essential protection and a sporty look



WOMEN'S RANGE



### Alice S3 Trainer - women's model

Ref. 62 30

Sizes: from 35 to 41

Low-top trainer for both comfort and femininity

- › Upper: water-repellent nubuck
- › Lining: 100% polyester, breathable, antibacterial, absorbent, anti-abrasion
- › Sole: anti-perforation PU, non-slip (SRC)
- › Toe cap: aluminium

Weight: 557g - Standardised S1P SRC shoe

#### ADVANTAGES

Flexible and comfortable  
Transparent non-marking outsole.

## SPORT RANGE

50  
ANS  
NEW  
2024



### Overture S3 Trainer

Ref. 65 41

Sizes: from 38 to 47

**Innovative and light low-top shoe with a dynamic look**

- › Upper: highly resistant, water-repellent fabric, made from environmentally-friendly materials
- › Lining: 100% SANY-DRY® polyester
- › Sole: Anti-perforation, thermal insulation, super non-slip, anti-torsion system
- › Toe cap: aluminium and TPU toe cap resistant to oil, grease and abrasion

Weight: 480 g - Standardised S3 SRC shoe

#### ADVANTAGES

Eco-friendly design, lightweight, technical, highly comfortable, memory foam sole



WHITE

BLACK

### Monti S3 Trainer

BLACK  
Ref. 65 40

WHITE  
Ref. 65 39

Sizes: from 38 to 47

**Low-top shoe in innovative Techshell fabric**

- › Upper: seamless, breathable, abrasion and tear-resistant
- › Lining: made from SANY-DRY® fabric
- › Sole: Anatomical, antistatic and flexible PU, shock absorbing, non-marking, non-slip, anti-perforation, resistant to abrasion, mineral oils and weak acids
- › Toe cap: aluminium

Weight: 520g - Standardised S3 SRC shoe

#### ADVANTAGES

Seamless, flexible, technical and comfortable, with non-marking white outsole.



### Running S1P Trainer

Ref. 65 11

Sizes: from 39 to 47

**White low-top shoe**

- › Upper: highly breathable BreaTEX fabric
- › Lining: fabric. Gusseted tongue to repel foreign bodies
- › Sole: in soft and comfortable PU, resistant to abrasion, mineral oils and weak acids, non-slip, anti-static and anti-perforation
- › Toe cap: aluminium

Weight: 460g - Standardised S1P SRC shoe

#### ADVANTAGES

Very flexible and light, with non-marking white outsole.



### Nuvolari S3 Trainer

Ref. 65 13

Sizes: from 37 to 47

**White low-top shoe**

- › Upper: water-repellent leather
- › Lining: breathable blue fabric. Gusseted tongue to repel foreign bodies
- › Sole: in soft and comfortable PU, resistant to abrasion, mineral oils and weak acids, non-slip, anti-static and anti-perforation
- › Toe cap: aluminium

Weight: 520 kg - Standardised S3 SRC shoe

#### ADVANTAGES

Very flexible and light, with non-marking white outsole.



CASUAL RANGE



**Buffalo S3 high-top shoe**

Ref. **68 00**

Sizes: from 40 to 47

**A timeless work shoe that never goes out of style**

- › Upper: water-repellent nubuck, sealed seams
- › Lining: 100% polyamide inside, breathable, absorbent, anti-abrasion. Protection against the cold
- › Sole: anatomical, antistatic, insulating against high temperature, heat-resistant (SRC) and non-slip (SRC)
- › Insulation against cold and heat (HI and CI)
- › Toe cap: non-metallic

**Weight: 755 g - Standardised S3 WR CI HI HRO SRC shoe**

**ADVANTAGES**

**Insulation against cold and heat, waterproof, metal-free**



50  
ANS

Gilles  
paint shop manager,  
North

Dulary offers both clothing and other kit. There's a wide choice of safety footwear, so everyone can find something they like, with the style they're looking for.

**The footwear ranges are really nice, and some models can be worn just like in town!**



**Tennis Blues S1P**

Ref. **62 10**

Sizes: from 35 to 47

**Low-top shoe in royal blue**

- › Lining: non-woven fabric
- › Sole: anti-perforation PU, anti-static, anti-abrasion and non-slip
- › Toe cap: steel

**Weight: 460g - Standardised S1P SRC shoe**

**ADVANTAGES**

**Trendy style, very light (canvas), comfortable and flexible.**

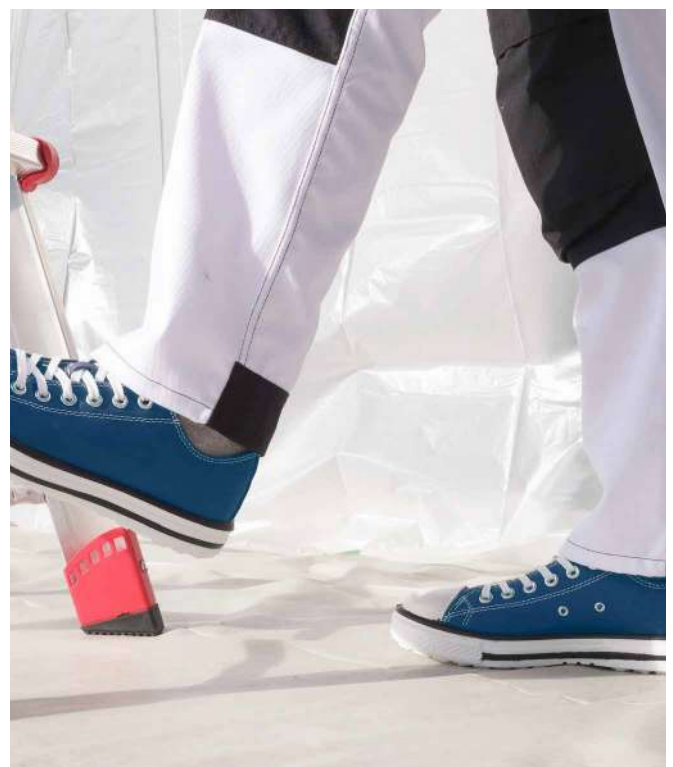



## THE ESSENTIALS



LOW-TOP

HIGH-TOP

### Black leather shoe S1P

LOW-TOP Ref. **60 13** | HIGH-TOP Ref. **60 12** | Sizes: from 38 to 47

- › Upper: pigmented croupon leather
- › Lining: polyamide mesh
- › Sole: non-metallic, anti-perforation, anti-static, non-slip, hydrocarbon-resistant PU
- › Toe cap: stainless steel

Weight (low): 630g - (high): 640g  
Standardised S1P SRC shoe



### Grey velour low-top S1P shoe

Ref. **60 16** | Sizes: from 38 to 47

- › Upper: split velour leather
- › Lining: polyamide
- › Sole: non-metallic, anti-perforation, anti-static, non-slip, hydrocarbon-resistant PU
- › Toe cap: stainless steel

Weight: 610 g - Standardised S1P SRC shoe



S5: for very damp environments where the ground is a risk. Anti-perforation sole

### Green safety boot S5

Ref. **69 10** | Sizes: from 39 to 46

- › Upper: PVC/green nitrile rubber
- › Lining: polyester
- › Sole: in anti-perforation PVC/nitrile rubber, resistant to acid, chemicals and hydrocarbons
- › Toe cap: stainless steel

Weight: 990g - Standardised S5 SRC boot



# CHOOSING YOUR GLOVES

4 ranges depending on use:

**Dulytek**  
HANDLING

**Dulytek**  
PRECISION

SINGLE USE  
CLEANING

## Protective glove standards:

**EN420 and EN ISO 21420:**  
General standard for glove design  
› safe (pH, chromium content)  
› size  
› dexterity  
› water vapour transmission

**EN388:**  
Protective gloves against mechanical risks

The standard is evolving: its revision concerns the cut resistance test and the addition of an impact test (optional).

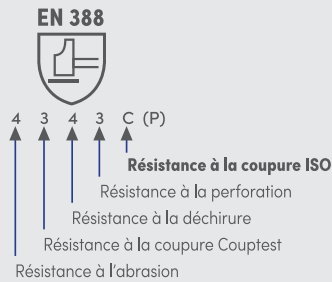

**EN ISO 374-1: 2016**  
Protection against chemical risks (permeation of hazardous non-gaseous chemicals) the standard is evolving: a single pictogram and three types of gloves

Type A ≥ 30 mins  
for at least  
6 products

EN ISO 374-1 / TYPE A



Type B ≥ 30 mins  
for at least  
3 products

EN ISO 374-1 / TYPE B



Type C ≥ 10 mins  
for at least  
1 product

EN ISO 374-1 / TYPE C



**ALL OUR GLOVES  
COMPLY WITH  
STANDARDS  
EN 420 AND  
EN ISO 21420**

## Dulytek

HANDLING

EN388: 3121X

### Nitrilight

Ref. **50 80** | Sizes: 9, 10  
(Sold in packs of 5)

Seamless knitted nylon.  
Smooth nitrile coating  
**Excellent adhesion on dry surfaces. No absorption of liquids on the inside. Dexterity and breathability**



EN388: 3131X

### Grip & Flex

Ref. **50 81** | Sizes: 9, 10  
(Sold in packs of 5)

Seamless knitted nylon.  
Crepe latex coating.  
Ventilated back to wick away perspiration  
**Superior adhesion in dry and wet weather. very high elasticity, compatibility with coatings such as: water/alcohols and ketones/diluted acids/biological proteins.**



EN388: 4X43D

### Protect Cut Polykor

Ref. **50 83** | Sizes: 9, 10  
(Sold in packs of 5)

Made of light and seamless Polykor knit  
PU coated gloves  
**Cut and abrasion resistance  
Exceptional dexterity on dry and wet surfaces  
Comfort and breathability**





## Dulytek

PRECISION

**BECAUSE RESPECT FOR THE ENVIRONMENT IS IMPORTANT TO DULURY,** the brand has innovated and expanded its range to include **G3RX gloves made from recycled plastic bottles.**



Seamless knitted lining made from 90% recycled PET and 10% elastane for comfort, dexterity and breathability

1 60 cl bottle = 1 pair



EN388: 4121X

### G3RX Resist & Confort

Ref. **50 90** | Sizes: **9, 10**  
(sold in packs of 5)

Nitrile foam coating  
Excellent dexterity and abrasion protection  
Excellent adhesion on dry and damp surfaces, oil-resistant  
Extremely comfortable against the skin



EN388: 2131X

### G3RX Grip Confort

Ref. **50 91** | Sizes: **9, 10**  
(sold in packs of 5)

Micro-surface latex coating, a revolutionary new surface treatment for superior adhesion  
Excellent adhesion to dry, slightly damp and non-oily surfaces  
Flexible and hard-wearing  
Very comfortable against the skin



EN388: 3X41B

### Preci Polykor

Ref. **50 84** | Sizes: **9, 10**  
(sold in packs of 5)

Made of light and seamless Polykor knit PU coated gloves

**Exceptional dexterity on dry and wet surfaces**  
**Resistance to cuts**  
**Compatible with touchscreens**



EN388: 3121X

### Slim Touch

Ref. **50 82** | Sizes: **9, 10**  
(sold in packs of 5)

Made of 18-gauge seamless knitted nylon  
Smooth nitrile coating

**Dexterity**  
**Breathability.**  
**Compatible with touchscreens**  
**Particularly suitable for jobs requiring extreme attention to detail**



EN388: 3131X

### PU gloves

White: **5069** (pack of 10) | Sizes: **White: 8, 9, 10 and 11**  
White: **5070** (indiv. bound) | Grey: **9, 10**  
Grey: **5072** (pack of 10)

Knitted glove with polyamide structure, polyurethane coating. Seamless.

**Fine handling requiring great dexterity and excellent touch.**  
**Breathable.**  
**Extremely good precision for painting work.**



GREY WHITE



**SINGLE USE**

	Nitrile glove	Latex glove	Vinyl glove
Puncture resistant	★★★★	★★	★
Stretch / Dexterity	★★★★	★★★★	★
Allergy risk		★	

**PROTECTION AGAINST CHEMICAL RISKS**

EN 374-1 type C



**Nitrile (non-powdered)**

Ref. **50 40** | Sizes: S/7 - M/8  
L/9 - XL/10

Reduces allergy risk for complete comfort and optimal sensitivity. Single use. Box of 100 gloves. **Economical gloves.**



**Latex (powdered)**

Ref. **50 30** | Sizes: S/6 - M/8  
L/10 - XL/12

Single use. Box of 100 gloves. **Economical gloves.**



**Vinyl (powdered)**

Ref. **50 35** | Sizes: S/7 - M/8  
L/9 - XL/10

Single use. Box of 100 gloves. **Economical gloves.**



**CLEANING**

EN 388 (1010) - EN 374-1 type B

**Yellow household glove**

Ref. **50 53** | One size: 9.5  
(Sold in packs of 5)

Natural latex, cotton flocking. Outer pattern finish. **Long. 30 cm.** **General purpose, flexible.**



EN 388 (3121) EN 374-1 type B

**Black neoprene**

Ref. **50 12** (Pack of 10 pairs) | Sizes: 9, 10  
Ref. **50 52** (Batches of 5)

Polychloroprene and latex, flocked cotton lining. Outer pattern finish. **Length 31 cm.** **Comfortable, flexible and non-adhesive. Versatile chemical resistance.**





# BREATHING PROTECTION

We offer 3 ranges of masks and associated accessories to cater for different types of use:

- single-use disposable masks
- reusable half-masks or full face masks with their corresponding filters in the Classic and Comfort ranges

## CHOOSING YOUR DISPOSABLE MASK



### 3 LEVELS OF PROTECTION

MASK TYPE		
FFP1 ANTI-AEROSOLS	FFP2 ANTI-AEROSOLS WITH VALVES	FFP3 ANTI-AEROSOLS WITH VALVES
LEVELS OF PROTECTION		
80%	94%	99%
POLLUTANT CLASS		
FFP1 SL NR	FFP2 SL NR	FFP3 SL NR
EXAMPLES OF PROTECTION		
Non-toxic dusts for concentrations up to 4 times the AEV (stops at least 80% of aerosols). Protects against particles of soft wood, cellulose, plaster, etc.	Low toxicity fine dust, fumes and mist for concentrations up to 10 times the AEV (stops at least 94% of aerosols). Same as FFP1 + hard wood, fibre glass, paint, hard metals, etc.	Highly toxic dust, toxic fumes and toxic mists, for concentrations up to 50 times the AEV (stops at least 99% of aerosols). Same as FFP1 + same as FFP2 + chromium, manganese, nickel, platinum, metal dusts and fumes, viruses and enzymes.

**AEV:** Average Exposure Value. This is the concentration measured over a reference period. (e.g. an 8-hour day). The AEV is indicated on the toxicity sheet of the products handled.

**NR:** non reusable - use is limited to one working day.

**R:** reusable

**SL:** filtration capacity for solid dusts (S) and liquid aerosols (S/L).



**SINGLE-USE**



How to correctly fit and adjust your breathing mask



**FFP1 anti-aerosol masks**

Ref. **54 10 21** (pack of 3 masks)

Ref. **54 10 10** (box of 20 masks)

FFP1 SL protective mask.



**FFP2 anti-aerosol masks with valve**

Ref. **54 15 21** (bag of 3 masks)

Ref. **54 15 15** (box of 10 masks)

FFP2 SL protective mask with exhalation valve



**FFP3 anti-aerosol masks with valve**

Ref. **54 20 21** (bag of 3 masks)

Ref. **54 20 20** (box of 5 masks)

FFP3 SL protective mask with exhalation valve.

**FREE DISPLAY BOX FOR 24 BOXES PURCHASED**

Ref. **9350 20**  
 To be stated on the order form



# BREATHING PROTECTION

## CHOOSING YOUR FILTER CARTRIDGES

The Classic and Comfort ranges are reusable and can be used with filters (inserts or cartridges).

### FILTER CODES

FIELD OF USE OF ANTI-GAS FILTERS	CATEGORY OF ANTI-PARTICULATE FILTERS ACCORDING TO FILTRATION EFFICIENCY	CATEGORY OF ANTI-GAS FILTERS ACCORDING TO THEIR AUTONOMY
<p><b>Type A (brown)</b> organic gases and vapours: benzene, diesel fuel, petrol.</p> <p><b>Type B (grey)</b> organic gases and vapours: chlorine, hydrogen sulphide, hydrocyanic acid, sulphuric acid.</p> <p><b>Type E (yellow)</b> sulphur dioxide, hydrochloric acid, acetic acid.</p> <p><b>Type K (green)</b> ammonia and derivatives</p>	<p><b>P1</b> low efficiency, non-toxic dust</p> <p><b>P2</b> Medium efficiency, toxic dust (wood, polyester resin, etc.), metal fumes</p> <p><b>P3</b> High efficiency, very toxic dust (asbestos, arsenic, etc.) lead, welding fumes</p>	<p><b>class 1</b> low capacity (insert)</p> <p><b>class 2</b> medium capacity (cartridge)</p> <p><b>class 3</b> large capacity (canister)</p>

### EXAMPLES OF USE

RANGE	FILTER TYPE	BRICK OR PLASTER DUST	LEAD DUST	FIBREGLASS ROCKWOOL	WHITE SPIRIT	ASBESTOS	ORGANIC GAS AND VAPOURS	INORGANIC GAS AND VAPOURS	AMMONIA	ACID GAS AND VAPOURS
Classic	A2P3R	✓	✓	✓	✓	✓	✓			
Comfort	P3	✓	✓	✓	✓					
	A2P3R	✓	✓	✓	✓	✓	✓			
	ABEK2P3	✓	✓	✓	✓	✓	✓	✓	✓	✓





## Half-mask, built-in P3 filters

Ref. **54 35 10** | Compatible filters P3:**54 35 20**

Made from odourless and hypoallergenic soft thermoplastic elastomer (no latex or silicon) with an easily adjustable harness. Net weight: 132 g. Made in Europe  
 Product particularly suited to sandpapering work  
 Compact, lightweight and flexible to fit the face perfectly.

### ADVANTAGES

- Better filtration than a disposable mask: 99.95%
- Long-lasting filters
- Full field of vision with no fogging
- Very airtight: 2% versus 5% for a disposable
- Soft, adapts to the face

			
<b>LIGHT</b> 132 G.	<b>COMFORTABLE</b>	<b>MADE IN EUROPE</b>	<b>REUSABLE</b>

↑  
**COMPATIBLE**  
 ↓



## P3 filters for P3 half-mask

Ref. **54 35 20** (packaging: 2 filters)

- › Replacement filters for the half-mask built-in P3 filters
- › Made in Europe
- Complies with standard EN 140:1998**
- Filters comply with standard EN 143: 2000 + A1:2006**
- CE certified masks and filters.**





**Michel**  
Plasterer, Centre

**I discovered this half-mask and quickly adopted it! It's 'P3', so it protects perfectly against dust, fumes and vapours you find on building sites.**

But above all, I find it economical and ecological: the filters last a long time, so there's no need to throw away and buy a new mask every time.

# BREATHING PROTECTION

## CLASSIC RANGE



### Half-mask with cartridges

Ref. **54 25 10** (box containing a half-mask, filters sold separately)

Compatible filters: **A2P3R (542521)**

Half-mask with cartridges for 2 screw-in filters. Made of thermoplastic rubber. Soft silicone exhalation valve. Simple, intuitive and ergonomic adjustment loop combined with a comfortable harness. **Complies with standard EN140:1998**

## COMFORT RANGE



### Comfort half-mask kit

Ref. **54 30 14**

Compatible filters: **A2P3R (543019)**

Ready-to-use half-mask kit: includes a half-mask + 2 A2P3R cartridges  
 › Very lightweight  
 › Quick and safe to apply with locking action  
 › Adjustable harness  
 › good visibility  
**Complies with standard EN140:1998**

#### ADVANTAGES

- Very light
- Easy to place on the face
- Easy to clean: can be disassembled in less than a minute

COMPATIBLE



### A2P3R Cartridges

Ref. **54 25 21** (pack of 2 cartridges)

**USE: GAS, ORGANIC VAPOURS, DUST AND VERY FINE TOXIC PARTICLES**

HDPE cartridge, activated carbon and PP non-woven filter materials. **Complies with standard EN143:2000+A1:2006, EN14387:2004+A1:2008**

COMPATIBLE



### A2P3R Cartridges

Ref. **54 30 19** (pack of 2 cartridges)

**USE: ORGANIC GASES AND VAPOURS, DUST AND VERY FINE TOXIC PARTICLES**

› Filtration material for gases: activated carbon;  
 For dust: Pleated fibre  
 › Non-deformable ABS container  
 › Class 2 gas filter; Class P3 particulate filter  
**Complies with standard EN143:2000+A1:2006, EN14387:2004+A1:2008**





### Comfort full face mask

Ref. **54 30 49**  
 (filters sold separately)

Compatible filters:  
**A2P3R (543019) - ABEK2P3R (543024)**

- Reusable full face mask with 2 filters and silicone seal.
- › Quick and safe to apply with locking action
  - › Optical class 1 (EN166) polycarbonate visor and polyamide filter holder
  - › Panoramic field of vision
  - › Anti-fog and scratch resistant mask
  - › 6-point fixed harness

#### ADVANTAGES

Comfortable: good weight distribution,  
 leaves no marks on the face  
 Panoramic field of view with no optical distortion



### ABEK2P3R Cartridges

Ref. **54 30 24** (pack of 2 cartridges)

**USE: ORGANIC AND INORGANIC GASES AND VAPOURS, ACID GASES, AMMONIA AND DERIVATIVES, DUST AND VERY FINE TOXIC PARTICLES**

- › Filtration material for gases: activated carbon;  
 For dust: Pleated fibre
  - › Non-deformable ABS container
  - › Class 2 gas filter; Class P3 particulate filter
- Complies with standard EN143:2000+A1:2006, EN14387:2004+A1:2008**



### A2P3 half-mask integrated filters

Ref. **54 30 58**

- Ready to use, maintenance-free half-mask
- › Mask: resistant, durable and holds its shape
  - › Perfectly airtight
  - › Easy to lower the mask without having to remove the helmet
  - › Excellent filtration performance
- Complies with standard EN 405 2001+A1:2009**

#### ADVANTAGES

As simple as a disposable, protects like a reusable  
 No maintenance required  
 High visibility



### Visor protection

Ref. **54 30 55**

Polyethylene visor protection  
 for Comfort full face mask.  
 Pack of 5 visors.



# EYE PROTECTION

## PROTECTION FROM MECHANICAL HAZARDS (CONSTRUCTION AND INDUSTRY)

### STANDARD EN 166:2001

specifies optical quality, resistance to common risks, mechanical risks, resistance to shocks/impacts.

### OTHER STANDARDS FOR PROTECTIVE EYEWEAR

- EN 170: Ultraviolet filter.
- EN 172: Sun protection filter for industrial use.
- EN 1836: Sun protection filter for leisure and sport.

**ALL OUR MODELS COMPLY WITH EN 166:2001 AND EN 170 (CLEAR LENS) OR EN 172 (TINTED LENS) STANDARDS**



### Wilco

Clear ref. <b>52 14</b>	Tinted ref. <b>52 15</b>
----------------------------	-----------------------------

**AFFORDABLE GOGGLES COMBINING COMFORT AND LIGHTNESS.**

- › Polycarbonate lenses (99.99% absorption of UVA and UVB rays).
- › Wraparound lens offering an unobstructed panoramic view.
- › Lightweight and frameless for permanent comfort.
- › Length-adjustable arms for better support.
- › Adjustable nose bridge. Scratch resistant
- › Weight: 28.7 g

#### ADVANTAGES

Comfort - lightweight - frameless



### Squadron

Clear ref. <b>52 17</b>	Tinted ref. <b>52 18</b>
----------------------------	-----------------------------

**THE COMBINATION OF STYLE AND COMFORT FOR ALL TYPES OF WORKING ENVIRONMENT.**

- › Polycarbonate lenses (99.99% absorption of UVA and UVB rays).
- › Frameless. Thin, flat, flexible arms that fit under any PPE.
- › Goggles with no metal parts
- › Reinforced K (certified) anti-scratch treatment and reinforced N (certified) anti-fogging treatment.
- › Weight: 28 g

#### ADVANTAGES

Style - comfort - flexibility



### Atlas

Ref. **52 16**

**THE ULTIMATE IN PROTECTIVE EYEWEAR WITH PANORAMIC VISION.**

- › Polycarbonate lenses (99.99% absorption of UVA and UVB rays).
- › Polyamide frame.
- › Adjustable and inclinable arms with flexible tips
- › Flexible nose bridge
- › Anti-scratch and anti-fogging.
- › Weight: 29.3 g

#### ADVANTAGES

Panoramic vision - comfortable





**PROTECTION AGAINST MECHANICAL,  
 DUST  
 AND CHEMICAL RISKS**



**Aegean overgoggles**

Ref. 52 20

COMFORTABLE AND LIGHTWEIGHT OVER GOGGLES WITH AN ACTIVE LOOK.

- › Sporty design
- › Polycarbonate lenses (99.99% absorption of UVA and UVB rays)
- › Lens curvature 3
- › Polycarbonate frame
- › Anti-scratch / Anti-fogging
- › Flexible and adjustable nose bridge and arms
- › Weight: 39.8 g

**ADVANTAGES**

Active look – lightweight – fully adjustable



**Sigma protective mask**

Ref. 52 25

EXTREMELY COMFORTABLE MASK DESIGNED TO FIT YOUR FACE PERFECTLY.

- › Polycarbonate lenses (99.99% absorption of UVA and UVB rays).
- › Lens curvature 5.5. Non-P PVC frame
- › Adjustable headband + quick-release headband for a better fit over prescription glasses or hard hat. Designed with 2 openings to be worn with protective glasses.
- › Anti-scratch / Anti-fogging
- › Weight: 133 g

**ADVANTAGES**

Extreme comfort – ventilated



**Flylux 60950**

Ref. 52 13

Eye skirt lined with EVA foam / UV400 mirror  
 Black nylon frame, EVA foam lining  
 CAT 1: light absorption between 20 and 57 %.

**ADVANTAGES**

Fits securely on the face / Full eye protection.  
 2-in-1 goggles: supplied with elasticated headband and arms (interchangeable).  
 Indoor/outdoor. Compliant with EN 172 and EN 1836.



**Vented mask**

Ref. 52 05

Polycarbonate lens. Flexible goggle frame made of PVC with air vents. Adjustable tightening elastic.



# HEAD PROTECTION

## 2 LEVELS OF PROTECTION

### PROTECTION AGAINST STATIONARY OBJECTS

WHITE



BLACK

#### Shock-resistant safety cap

white ref. **71 05 15**    Black ref. **71 05 16**

Shock-resistant baseball-type cap. Protects the wearer when their head is hit by hard and still objects. Composed of a moulded ABS shell with comfort foam. Rip-tab strip adjustment. side vents  
**Standard EN 812: 2012**



### PROTECTION AGAINST FALLING OBJECTS



#### White hard hat

Ref. **71 05 10**

Protects the wearer against falling objects and head injuries and subsequent brain trauma.  
> 30 °C: shockproof and resistant to extremely low temperatures  
> 440 V: electric isolation (protection against brief contact with a maximum 440 V conductor)

**EC standards EN 397:2012+A1:2012 + EN50365:2002.**

HD PE shell  
Serrated wheel (excellent hold between the fingers) - 6 attachment points  
370 g



#### Baseball-type white hard hat

Ref. **71 05 11**

8 attachment points = comfortable to use retro-reflective strip  
Chinstrap  
Adjustable size, innovative tightening system.

#### Badge holder

Ref. **71 05 12**

Compatible with the baseball-type white hard hat 710511

#### Noise-cancelling ear-plugs with steel ball

Ref. **71 05 05**

Moderate hearing protection  
Washable and reusable  
Practical with the drawcord to keep the plugs around the neck  
**Standard: EN 352-2:2022**  
Sold in bags of 10.



#### ADVANTAGES

Washable and reusable

#### Noise-cancelling headphones 32.1dB SNR

Ref. **71 05 21**

Increased hearing protection  
**Standard: EN 352-1: 2002.**  
Grey ABS shell, adjustable and foldable hoop. Pocket model, PVC pad with leather feel. Weight: 25 g.



#### ADVANTAGES

Folds into the pocket  
Reusable



## First aid kit

Ref. **71 15 08**

Practical and flexible first aid kit.  
L15 x H12 x D5 cm  
4 person



Slots easily  
into the glove  
box



## Special construction industry first aid kit

Ref. **71 15 10**

For 5 people.



## High-vis vest

Ref. **71 07 10**

One size: XL.  
Class 2.



## Warning sign tape

Ref. **71 10 10** | Dimensions:  
5 cm x 100 m

Sold in packs  
of 12 rolls.



## Fall prevention kit

Ref. **71 20 01**

1 full harness with sub-pelvic strap, three attachment points:  
1 dorsal steel D-ring and 2 textile sternal loops.  
EC standard EN3611. Polyamide work positioning lanyard  
measuring 2 m long and 14 mm in diameter, supplied with  
two steel carabiners with zinc-plated screws.  
EC standards EN 358 and EN 362  
1 temporary 1 m polyester anchor strap with 2 steel  
D-buckles (horizontal work)  
EC standard EN 795. Weight: 2,320 g.  
Capacity: 100 kg user

### ADVANTAGES

Complete kit packed in a carry bag.



## Carabiner

Ref. **71 22 10**

Steel carabiner.  
Automatic 1/4 turn closure.  
EC type 1503. Issue 5  
Extension 1.  
Standard EN 362:2004.

### ADVANTAGES

**Robustness.**  
**Easy opening and closing.**



# A COMPLETE MERCHANDISING RANGE FOR YOUR SALES OUTLET

We provide you with various tools to optimise the presentation of Dulary products in your sales outlets and promote their resale.

Our team is here to listen to you and help you promote your sales outlet. Different media for different content: information, advice on use, display, etc.



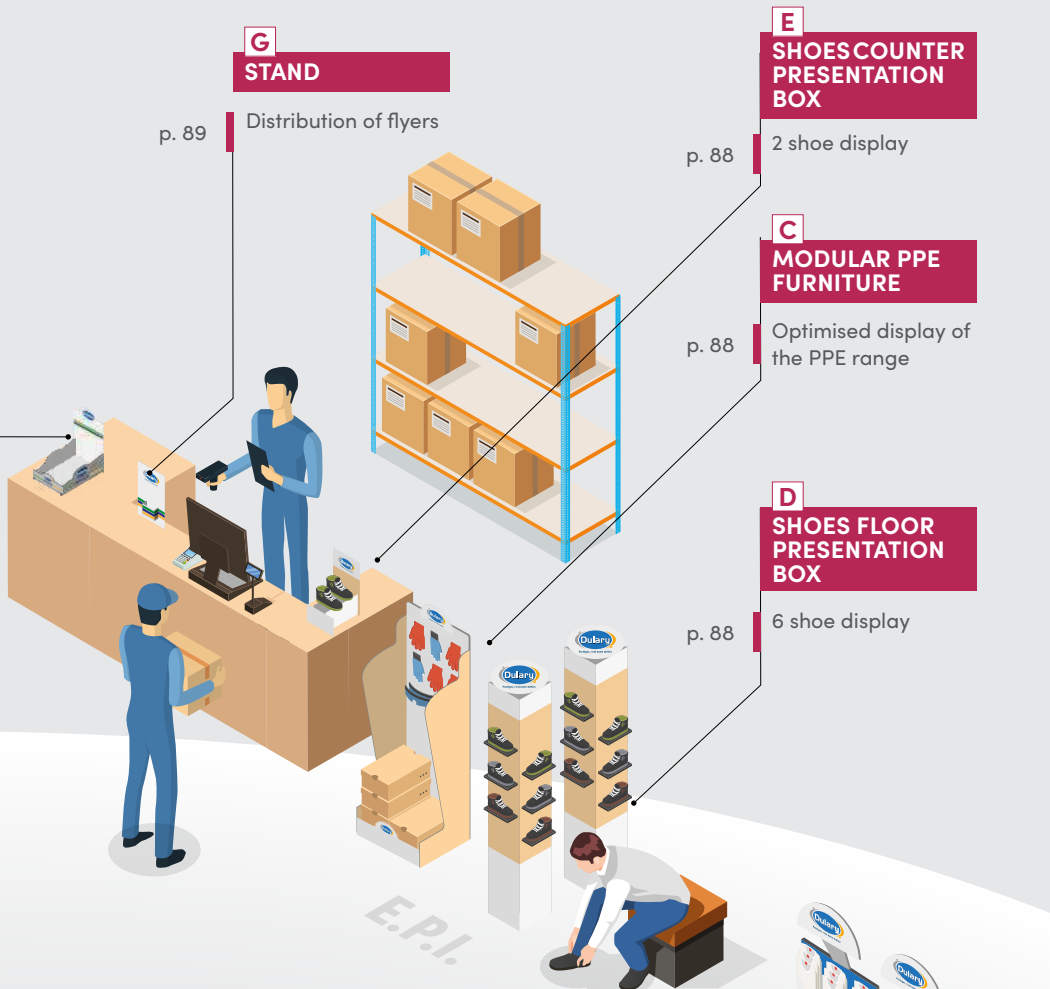

**G**  
**STAND**

p. 89 Distribution of flyers

**E**  
**SHOESCOUNTER PRESENTATION BOX**

p. 88 2 shoe display

**C**  
**MODULAR PPE FURNITURE**

p. 88 Optimised display of the PPE range

**D**  
**SHOES FLOOR PRESENTATION BOX**

p. 88 6 shoe display



Sophie  
PPE department manager  
in a paint shop, South East

**A trusted partner!**

I've been working with Dulary for over 20 years now and I'm always satisfied with the products and the services offered: everything is done to help us with in-store resale.

Tools, advice and support to help you work more efficiently in-store - that's the Dulary difference!

**R**  
**RACK**

p. 89 Display of garments on hangers to showcase flagship products

**K**  
**GONDOLA END**

p. 89 Full display of the fabric range

**H**  
**MANNEQUIN**

p. 89 Worn clothing

**I**  
**SHOP MANNEQUIN**

p. 89 Worn clothing

VÊTEMENTS PROFESSIONNELS



**SITE**

**PPE**



**A** Biosourced back panel for pallet of rolls

Ref. **FRONTONPALDULYBIO**

L81 cm – D37 cm – H160 cm

**C** Modular PPE furniture

Ref. **930001**

L60 cm – D60 cm – H161 cm

**E** Counter presentation box 2 shoes

Ref. **PRESCPTOIR2CHAUS**

L. 26 cm – H. 46.5 cm – D. 32 cm  
2 shoes



**B** Back panel for pallet of rolls

Ref. **FRONTONBOBINEAU**

L81 cm – D37 cm – H160 cm

**D** Floor presentation box 6 shoes

Ref. **PRESSOL6CHAUS**

L. 54.3 cm – H. 171.7 cm – D. 30.3 cm  
6 shoes



**Arthur,**  
*Paint shop manager,  
Ile-de-France*

**Dulary, a leading brand on the market.**

There's no question about it, it's a well-known and recognised brand, with a wide range of quality products for protection and PPE, so I have every confidence in it!



# FURNITURE / POS DISPLAY

## COUNTER

## CLOTHING

A functional, well-presented counter is sure to get you noticed!



**F** Multi-product counter presentation box

Ref. PRESENTOIRMULTI

L 23 cm - D 34 cm - H 35 cm



**G** Counter stand

Ref. CHEVALETDULARY

L 25 cm - H 40 cm



**H** Mannequin

Ref. MASCOTMANNEQUIN



**J** Rack

Ref. PORTANTDULARY

L 60 cm - D 60 cm - H 161 cm  
Capacity: holds around 20 garments on hangers



**I** Shop mannequin

Ref. BUSTE



**K** Metal gondola 1 m

Ref. 40 10 11

L. 100 cm - H. 215 cm - D. 50 cm  
Capacity: approx. 100 garments

Ref. BARRE1M | Display rail

Hooks to a 1 m wide gondola

2 configurations: with pegs, or with a rail





## DULARY supports you in France and throughout Europe

### 2 SITES IN FRANCE



#### SUCY-EN-BRIE

ZAC de la Sablière  
11 avenue de la Sablière  
94370 SUCY-EN-BRIE  
[dulary-idf@dulary.com](mailto:dulary-idf@dulary.com)

#### SAINTE-SIGOLÈNE

ZI Les Taillas  
Allée Louis Pasteur  
43600 SAINTE-SIGOLÈNE  
[dulary-sud@dulary.com](mailto:dulary-sud@dulary.com)

### YOUR CONTACTS

Ile de France sales:	<b>+33 (0)6 24 38 38 46</b>
North region sales:	<b>+33 (0)6 60 18 18 92</b>
South-West region sales:	<b>+33 (0)7 71 72 99 98</b>
South-East region sales:	<b>+33 (0)6 21 84 32 31</b>
Dulary Head Office:	<b>+33 (0)1 49 82 04 04</b>
Outside France:	<b><a href="mailto:international@multiplast-dulary.com">international@multiplast-dulary.com</a></b>

### ORDERS DEPARTMENT

#### SUCY-EN-BRIE

Tel. +33 (0)1 49 82 04 04  
Fax: +33 (0)1 49 82 04 05  
[appro-idf@dulary.com](mailto:appro-idf@dulary.com)

#### SAINTE-SIGOLÈNE

Tel. +33 (0)4 71 75 14 39  
Fax: +33 (0)4 71 75 68 10  
[appro-sud@dulary.com](mailto:appro-sud@dulary.com)

[dulary.fr](http://dulary.fr)